

Reference Manual
Professional Temperature Calibrator
Jofra PTC-125/155/350/425/660 A/B/C

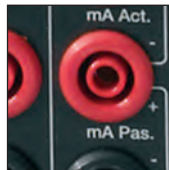

Reference Manual

Professional Temperature Calibrator

JOFRA PTC-125/155/350/425/660 A/B/C

© Copyright 2012 AMETEK Denmark A/S



About this manual....

- **The structure of the manual**

This manual is divided into 10 chapters. These describe how to set up, operate, service and maintain the calibrator. The technical specifications are described and accessories may be ordered from the list of accessories.

Along with the calibrator, you should have received a multi-lingual user manual, which sets out the operating instructions for the instrument. It is designed to provide a quick reference guide for use in the field.

- **Safety symbols**

This manual contains a number of safety symbols designed to draw your attention to instructions that must be followed when using the instrument, as well as any risks involved.



Warning

Conditions and actions that may compromise the safe use of the instrument and result in considerable personal injury or material damage.



Caution...

Conditions and actions that may compromise the safe use of the instrument and result in slight personal or material damage.



Note...

Special situations, which demand the user's attention.

List of contents

1.0	Introduction	5
1.1	Warranty	7
2.0	Safety instructions	8
3.0	Setting up the calibrator	13
3.1	Receipt of the calibrator	13
3.2	Preparing the dry-block calibrator.....	15
3.2.1	When setting up the dry-block calibrator, you must.....	17
3.2.2	Choice of insertion tube	19
3.2.3	Inserting the sensors.....	20
3.3	Programming intelligent sensors	22
4.0	Operating the Calibrator	23
4.1	Standard connections	23
4.2	Input modules (B and C versions only).....	25
4.3	Keyboard and main screen display overview	27
4.3.1	Main screen display information	30
4.3.2	Main screen temperature values.....	32
4.3.3	Stability of temperature values.....	32
4.4	Operating principle.....	33
4.4.1	Horizontal Menu.....	33
4.4.2	Vertical Menu	34
4.4.3	Parameter Fields.....	35
4.4.4	Working with lists	37
4.5	Starting the calibrator.....	40
4.6	Setting the temperature	41
4.7	Calibration (optional).....	41
4.7.1	Running a calibration	43
4.7.2	Viewing calibration results	47
4.7.3	Displaying calibration information	48
4.7.4	Deleting workorders	50
4.8	Switch test menu	51
4.8.1	Running a switch test.....	52
4.8.2	Showing switch test results.....	54
4.9	Auto step menu.....	58
4.9.1	Running an Auto step calibration.....	58
4.9.2	Auto Step test results.....	61
4.10	Sensor Setup menu	63
4.10.1	Setting the additional stability time (A version).....	63
4.10.2	Setting the parameters for TRUE – reference sensor (B	

	and C versions only)	64
4.10.3	Setting the parameters for SUT– Sensor under test (B versions only)	66
4.10.4	Viewing the Reference data (B and C versions only)	68
4.11	Calibrator Setup menu	69
4.11.1	Setting the temperature parameters	69
4.11.2	Setting the temperature resolution.....	71
4.11.3	Setting the sound and volume	72
4.11.4	Setting calibration interval.....	72
4.11.5	Choosing a language (optional)	73
4.11.6	Changing the date and time.....	73
4.11.7	Saving a setup	74
4.11.8	Loading a setup	75
4.11.9	Resetting the instrument setup to factory defaults.....	75
4.11.10	Network Configuration (for service use only)	76
4.12	Information Screen	77
4.13	About the calibrator.....	78
4.14	Simulation or training	78
5.0	After use.....	80
5.1	Storing and transporting the calibrator	80
6.0	Replacing the main fuses	83
6.1	Error messages.....	84
6.2	Returning the calibrator for service.....	86
7.0	Maintenance	89
7.1	Cleaning.....	89
7.2	Adjusting and calibrating the instrument.....	91
7.3	Maintenance of STS-reference sensor.....	92
7.4	Testing the overtemperature function	94
8.0	Technical specifications	95
9.0	List of accessories	128
10.0	Standard insertion tubes	130

1.0 Introduction

Congratulations on your new AMETEK JOFRA PTC Calibrator!

With this AMETEK JOFRA calibrator, you have chosen an extremely effective instrument, which we hope will live up to all your expectations. Over the past many years, we have acquired extensive knowledge of industrial temperature calibration. This expertise is reflected in our products, which are all designed for daily use in an industrial environment. Please note that we are very interested in hearing from you, if you have any ideas or suggestions for changes to our products.

This reference manual applies to the following instruments:

- **JOFRA PTC-125 A - Temperature calibrator**
- **JOFRA PTC-125 B - Temperature calibrator with sensor and reference inputs**
- **JOFRA PTC-125 C - Temperature calibrator with reference input**
- **JOFRA PTC-155 A - Temperature calibrator**
- **JOFRA PTC-155 B - Temperature calibrator with sensor and reference inputs**
- **JOFRA PTC-155 C - Temperature calibrator with reference input**
- **JOFRA PTC-350 A – Temperature calibrator**
- **JOFRA PTC-350 B – Temperature calibrator with sensor and reference inputs**
- **JOFRA PTC-350 C - Temperature calibrator with reference input**
- **JOFRA PTC-425 A – Temperature calibrator**
- **JOFRA PTC-425 B – Temperature calibrator with sensor and reference inputs**
- **JOFRA PTC-425 C - Temperature calibrator with reference input**
- **JOFRA PTC-660 A – Temperature calibrator**
- **JOFRA PTC-660 B – Temperature calibrator with sensor and reference inputs**
- **JOFRA PTC-660 C - Temperature calibrator with reference input**

Model A



Model B



Model C



ISO-9001 certified

AMETEK Denmark A/S was ISO-9001 certified in September 1994 by Bureau Veritas Certification Denmark.

CE-label



Your new temperature calibrator bears the CE label and conforms to the Electromagnetic Compatibility (EMC) Directive 2014/30/EU and the Low Voltage Directive 2014/35/EU and RoHS Recast (RoHS II) Directive 2011/65/EU*.

Technical assistance

Please contact the dealer from whom you acquired the instrument if you require technical assistance.

* PTC-125 A / PTC-125 B / PTC-125 C from serial no. xxxxxx-00243, PTC-155 A / PTC-155 B / PTC-155 C from serial no. xxxxxx-00283, PTC-350 A / PTC-350 B / PTC-350 C from serial no. xxxxxx-00203, PTC-425 A / PTC-425 B / PTC-425 C from serial no. xxxxxx-00086 and PTC-660 A / PTC-660 B / PTC-660 C from serial no. xxxxxx-00290.

1.1 Warranty

This instrument is warranted against defects in workmanship, material and design for two (2) years from date of delivery to the extent that AMETEK will, at its sole option, repair or replace the instrument or any part thereof which is defective, provided, however, that this warranty shall not apply to instruments subjected to tampering or, abuse, or exposed to highly corrosive conditions.

THIS WARRANTY IS IN LIEU OF ALL OTHER WARRANTIES WHETHER EXPRESS OR IMPLIED AND AMETEK HEREBY DISCLAIMS ALL OTHER WARRANTIES, INCLUDING, WITHOUT LIMITATION, ANY WARRANTY OF FITNESS FOR A PARTICULAR PURPOSE OR MERCHANTABILITY. AMETEK SHALL NOT BE LIABLE FOR ANY INCIDENTAL OR CONSEQUENTIAL DAMAGES, INCLUDING, BUT NOT LIMITED TO, ANY ANTICIPATED OR LOST PROFITS.

This warranty is voidable if the purchaser fails to follow any and all instructions, warnings or cautions in the instrument's User Manual.

If a manufacturing defect is found, AMETEK will replace or repair the instrument or replace any defective part thereof without charge; however, AMETEK's obligation hereunder does not include the cost of transportation, which must be borne by the customer. AMETEK assumes no responsibility for damage in transit, and any claims for such damage should be presented to the carrier by the purchaser.

2.0 Safety instructions



Read this manual carefully before using the instrument!

In order to avoid any personal injuries and/or damage to the instrument all safety instructions and warnings must be observed.

The screen menus shown in this manual represent the menus displayed when using a B-version.



Disposal – WEEE Directive

These calibrators contain Electrical and Electronic circuits and must be recycled or disposed of properly (in accordance with the WEEE Directive 2012/19/EU).



Warning

About the use:

- The calibrator **must not** be used for any purposes other than those described in this manual, as it might cause a hazard.
- The calibrator has been designed for **indoor use only** and is not to be used in wet locations.
- The calibrator is **not to be used in hazardous areas**, where vapour or gas leaks, etc. may constitute a danger of explosion.
- The calibrator is a CLASS I product and must be connected to a mains outlet with a protective earth connection. Ensure the ground connection of the calibrator is properly connected to the protective earth before switching on the calibrator. Always use a mains power cable with a mains plug that connects to the protective earth.
- To ensure the connection to protective earth any extension cord used **must** also have a protective earth conductor.

- Only use a mains power cord with a current rating as specified by the calibrator and which is approved for the voltage and plug configuration in your area.
- Before switching on the calibrator make sure that it is set to the voltage of the mains electricity supply.
- **Always** position the calibrator to enable easy and quick disconnection of the power source (mains inlet socket).
- The calibrator **must** be kept free within an area of 20 cm on all sides and 1 metre above the calibrator due to fire hazard.
- **Never** use heat transfer fluids such as silicone, oil, paste, etc. in the dry-block calibrators. These fluids may penetrate the calibrator and cause electrical hazard, damage or create poisonous fumes.
- The calibrator **must** be switched off before any attempt to service the instrument is made. There are no user serviceable parts inside the calibrator.
- When cleaning the well or the insertion tube, **REMEMBER** to wear goggles when using compressed air in the dry-block calibrator.
- Use protection shield when calibrating at high temperatures (PTC-660)
- The PTC-125 contains R-1270 and R-704 under pressure. The calibrator must **under no circumstances** be stored at ambient temperatures above 50°C (122°F) or operated at ambient temperatures above 40°C (104°F). Doing so may cause a hazard.

About the front panel:

- For B and C versions only, the sockets on the input module must **NEVER** be connected to voltages exceeding 30V with reference to ground.
- Thermostats must not be connected to any other voltage sources during test.

About insertion tubes, insulation plugs, well and sensor:

- **Never** leave hot insertion tubes which have been removed from the calibrator unsupervised – they may constitute a fire hazard or personal injury.

If you intend to store the calibrator in the optional carrying case after use, you **must** ensure that the instrument has cooled down to a temperature **below 100°C/212°F** before placing it in the carrying case.

- **Never** place a hot insertion tube in the optional carrying case.

About the fuses:

- The fuse box must not be removed from the power control switch until the mains cable has been disconnected.
- The two main fuses must have the specified current and voltage rating and be of the specified type. The use of makeshift fuses and the short-circuiting of fuse holders are prohibited and may cause a hazard.



Caution – Hot surface

This symbol is engraved in the grid plate. 

- **Do not touch** the grid plate, the well or the insertion tube when the calibrator is heating up – they may be very hot and cause burns.
- **Do not touch** the tip of the sensor when it is removed from the insertion tube/well – it may be very hot and cause burns.
- **Do not touch** the handle of the calibrator during use – it may be very hot and cause burns.
- **Over 50°C/122°F**

If the calibrator has been heated up to temperatures above 50°C/122°F, you must wait until the instrument reaches a temperature **below 50°C/122°F** before you switch it off.

- **Do not** remove the insert from the calibrator before the insert has cooled down to less than 50°C/122°F.



Caution – Cold surface

Below 0°C/32°F

(applies only to the PTC-125/155 A/B/C models)

- **Do not** touch the well or insertion tube when these are below 0°C/32°F - they might create frostbite.
- If the calibrator has reached a temperature below 0°C/32°F, ice crystals may form on the insertion tube and on the well. This, in turn, may cause the material surfaces to oxidize.

To prevent this from happening, the insertion tube and the well must be dried. This is done by heating up the calibrator to min. 100°C/212°F until all water left has evaporated.

Remove the insulation plug while heating up.

It is very important that humidity in the well and insertion tube is removed to prevent corrosion and frost expansion damages.



Caution...

About the use:

- **Do not** use the instrument if the internal fan is out of order.
- Before cleaning the calibrator, you **must** switch it off, allow it to cool down and remove all cables.

About the well, insertion tube and sensor:

- The well and the insertion tube **must** be clean and dry before use.
- **Do not** pour any form of liquids into the well. It might damage the well or cause a hazard.
- Scratches and other damage to the insertion tubes should be avoided by storing the insertion tubes carefully when not in use.

- The insertion tube must **never** be forced into the well. The well could be damaged as a result, and the insertion tube may get stuck.
- **Before** using new insertion tubes for the calibration, the insertion tubes **must** be heated up to maximum temperature 350°C (662°F) / 425°C (797°F) / 660°C (1220°F) for a period of minimum 30 minutes (PTC-350/425/660 A/B/C only).
- The insertion tube must **always** be removed from the calibrator after use. The humidity in the air may cause corrosion oxidation on the insertion tube inside the instrument. There is a risk that the insertion tube may get stuck if this is allowed to happen.
- If the calibrator is to be transported, the insertion tube **must** be removed from the well to avoid damage to the instrument.



Note...

The product liability **only** applies if the instrument is subject to a manufacturing defect. This liability becomes void if the user fails to follow the instructions set out in this manual or uses unauthorized spare parts.

3.0 Setting up the calibrator

3.1 Receipt of the calibrator

When you receive the instrument...

- Carefully unpack and check the calibrator and the accessories.
- Check the parts against the list shown below.

If any of the parts are missing or damaged, please contact the dealer who sold the calibrator.

You should receive:

- 1 calibrator
-

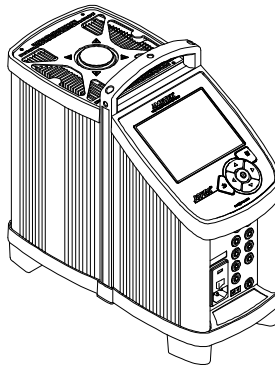

- 1 mains cable
-

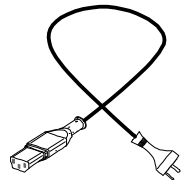

- 2 sets of test cables (2 black, 2 red – B versions only)
-



- 1 USB key containing reference manual and software package “JOFRACAL”
-



- 1 USB cable
-

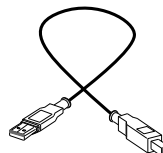

- 1 tool for insertion tube

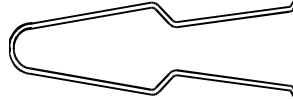

-
- 1 traceable certificate (A versions)

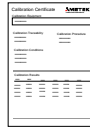

-
- 2 traceable certificates (C versions)



-
- 3 traceable certificates (B versions)



-
- 1 set of silicone plugs for insulation plugs (PTC-125/155 only)



-
- 1 heat shield (PTC-660 only)

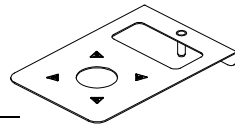

When reordering, please specify the part numbers found in the list of accessories, chapter 9.0.

Optional parts can also be found in the list of accessories.

3.2 Preparing the dry-block calibrator



Warning

- The calibrator **must not** be used for any purposes other than those described in this manual, as it might cause a hazard.
- The calibrator has been designed for **indoor use only** and is not to be used in wet locations.
- The calibrator is **not to be used in hazardous areas**, where vapour or gas leaks, etc. may constitute a danger of explosion.
- The calibrator is **not** designed for operation in altitudes above 2000 meters.
- The calibrator is a CLASS I product and must be connected to a mains outlet with a protective earth connection. Ensure the ground connection of the calibrator is properly connected to the protective earth before switching on the calibrator. Always use a mains power cable with a mains plug that connects to the protective earth.
- To ensure the connection to protective earth any extension cord used **must** also have a protective earth conductor.
- Only use a mains power cord with a current rating as specified by the calibrator and which is approved for the voltage and plug configuration in your area.
- Before switching on the calibrator make sure that it is set to the voltage of the mains electricity supply.
- **Always** position the calibrator to enable easy and quick disconnection of the power source (mains inlet socket).
The calibrator **must** be kept free within an area of 20 cm on all sides and 1 metre above the calibrator due to fire hazard.

- The PTC-125 contains R-1270 and R-704 under pressure. The calibrator must **under no circumstances** be stored at ambient temperatures above 50°C (122°F) or operated at ambient temperatures above 40°C (104°F). Doing so may cause a hazard.
- After transport or storage in humid conditions or if the calibrator has not been heated up to minimum 100°C within the last 10 days, the instrument needs to be operated with a well temperature of at least 140°C for 2 hours before it can be assumed to meet all safety requirements of EN61010-1 (PTC-350/425/660 only).
- If the calibrator is wet or has been in a wet environment, do not apply power until the moisture has been removed for example by storage at 50°C in a low humidity environment for at least 4 hours.



Note...

The instrument must **not** be exposed to draughts.

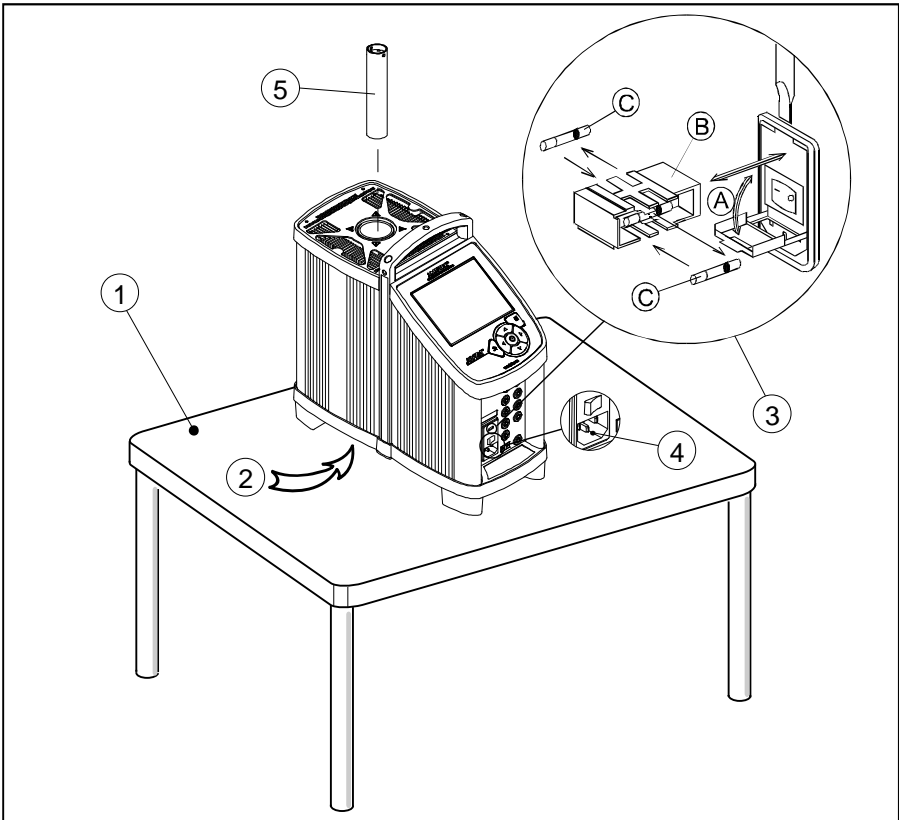

Fig. 1

3.2.1 When setting up the dry-block calibrator, you must...

- ① Place the calibrator on an even horizontal surface where you intend to use it.



Caution...

- **Do not** use the instrument if the internal fan is out of order.
- ② Ensure a free supply of air to the internal fan located at the bottom of the instrument. The area around the calibrator should be free of draught, dirt, flammable substances, etc.

- ③ Check that the fuse size corresponds to the applied voltage on. The fuse is contained in the power control switch (on/off switch). To check; do as follows (see fig. 1):



Warning

The two main fuses must have the specified current and voltage rating and be of the specified type. The use of makeshift fuses and the short-circuiting of fuse holders are prohibited and may cause a hazard.

- A. Open the fuse box lid using a screwdriver.
 - B. Take out the fuse box.
 - C. Remove both fuses replacing them with two new fuses. These must be identical and should correspond to the line voltage. See chapter 9.0.
 - B. Slide the fuse box back into place.
- ④ Check that the earth connection for the instrument is present and attach the cable.
- ⑤ Select an insertion tube with the correct bore diameter. See section 3.2.2 for information on how to select insertion tubes.

The calibrator is now ready for use.

3.2.2 Choice of insertion tube



Caution...

To get the best results out of your calibrator, the insertion tube dimensions, tolerance and material are critical. We highly advise using the JOFRA insertion tubes, as they guarantee trouble free operation. Use of other insertion tubes may reduce performance of the calibrator and cause the insertion tube to get stuck.



Caution...

- **Before** using new insertion tubes for calibration in the PTC-350/660 instruments, the insertion tubes **must** be heated up to maximum temperature 350°C (662°F) / 425°C (797°F) / 660°C (1220°F) for a period of minimum 30 minutes (PTC-350/425/660 A/B/C only).

Insertion tubes are selected on the basis of the diameter of the sensor to be calibrated.

Use the table for insertion tubes in chapter 9.0 to find the correct part number.

Alternatively, you may order an undrilled insertion tube and drill the required hole yourself. The finished dimensions should be as follows:

- Sensor diameter +0.2mm +0.05/-0
- Reference sensor holes : Ø4.2mm +0.05/-0

For PTC-125/155 A/B/C only:

In order to get optimum results and prevent ice from building up in the well of the cooling calibrators, a proper sized insulation plug must be placed over the well during the calibration process.

The holes in the plug must have a tight fit and unused holes must be covered using e.g. silicone plugs (spare part no. 126280).

3.2.3 Inserting the sensors

Before inserting the sensors and switching on the calibrator, please note the following important warning:



Warning

Never use heat transfer fluids such as silicone, oil, paste, etc. in the dry-block calibrator. These fluids may penetrate the calibrator and cause electrical hazard, damage or create poisonous fumes.

Insert the sensors as shown in fig. 2.

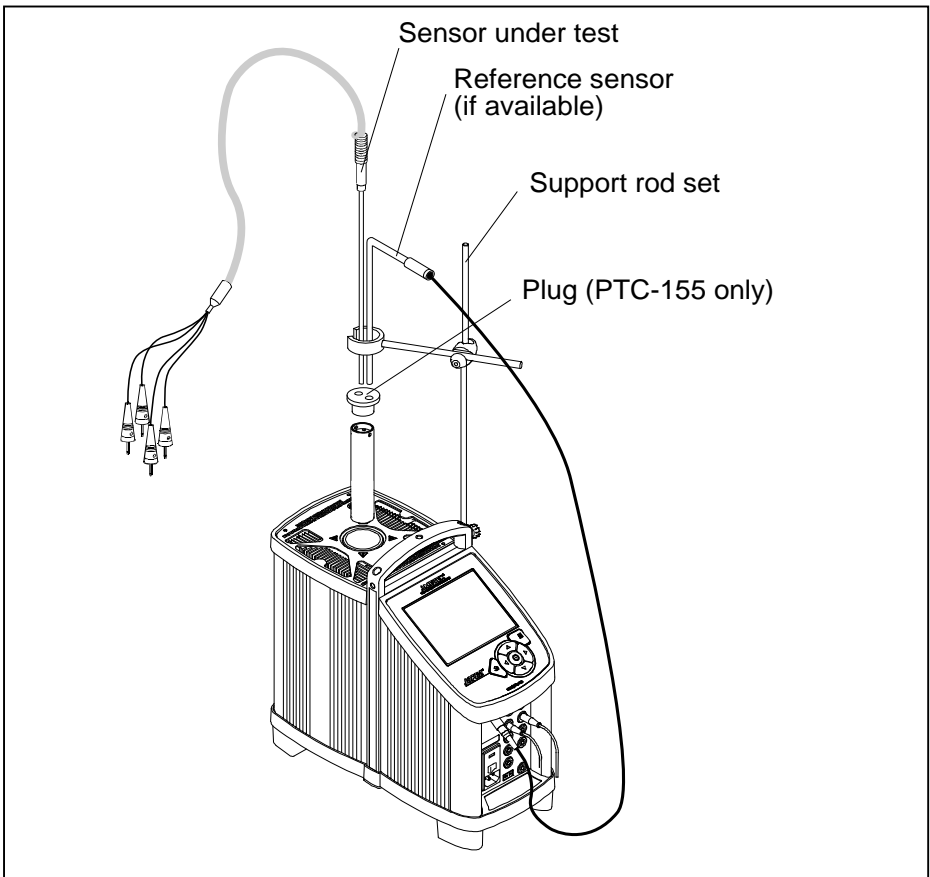

Fig. 2



Caution...

- The well and the insertion tube **must** be clean before use.
- Scratches and other damage to the insertion tubes should be avoided by storing the insertion tubes carefully when not in use.
- The insertion tube must **never** be forced into the well. The well could be damaged as a result, and the insertion tube may get stuck.



Caution – Hot surface

- **Do not touch** the grid plate, the well or the insertion tube while the calibrator is heating up – they may be very hot and cause burns.
- **Do not touch** the tip of the sensor when it is removed from the insertion tube – it may be very hot and cause burns.
- **Do not touch** the handle of the calibrator during use – it may be very hot and cause burns.
- **Do not** remove the insert from the calibrator before the insert has cooled down to less than 50°C/122°F.



Caution – Cold surface

- If the calibrator has reached a temperature below 0°C/32°F, ice crystals may form on the insertion tube and on the well. This, in turn, may cause the material surfaces to oxidize.
To prevent this from happening, the insertion tube and the well must be dried. This is done by heating up the calibrator to min. 100°C/212°F until all water left has evaporated.
Remove the insulation plug while heating up.
It is very important that humidity in the well and insertion tube is removed to prevent corrosion and frost expansion damages.
- **Do not** touch the well or insertion tube when these are below 0°C/32°F – they might create frostbite.

3.3 Programming intelligent sensors

Use the configuration software CON050 supplied with PTC to program and to update calibration information in intelligent sensors.

For instructions read the software manual for CON050 installed on the USB key.

4.0 Operating the Calibrator

4.1 Standard connections

Communication connections (all versions)

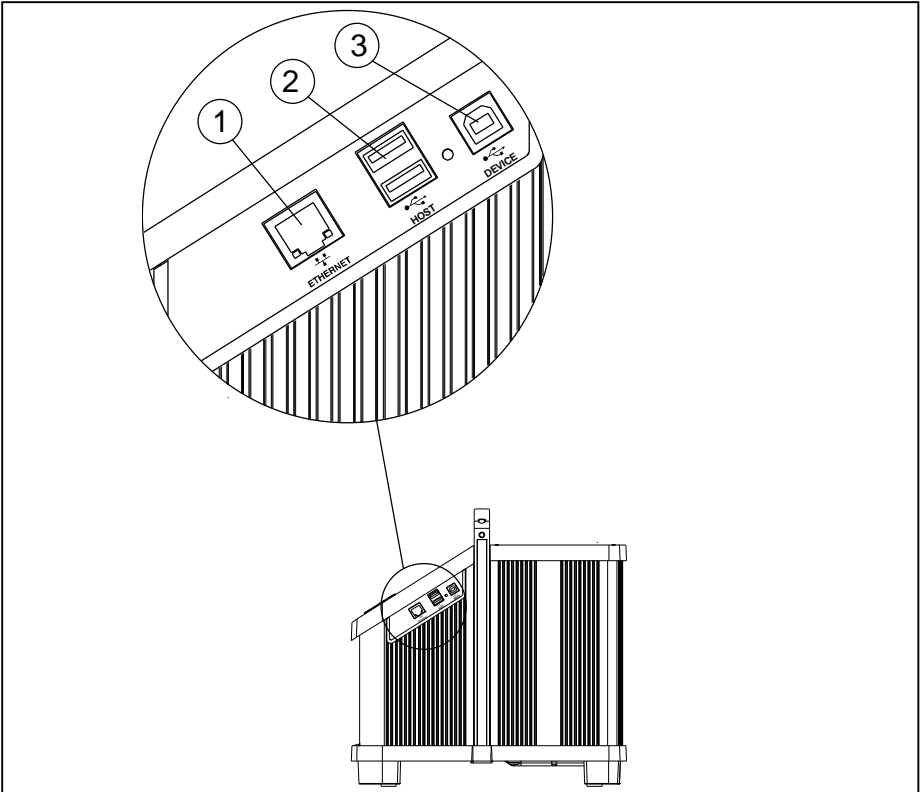

Fig. 3

Pos.	Description
1	Ethernet: Ethernet MAC 10/100 base-T, RJ45
2	Host: USB 2.0 Double Host Port, 2 x USB A
3	Device: USB 2.0 Device Port, 1 x USB B

Standard connections (all versions)

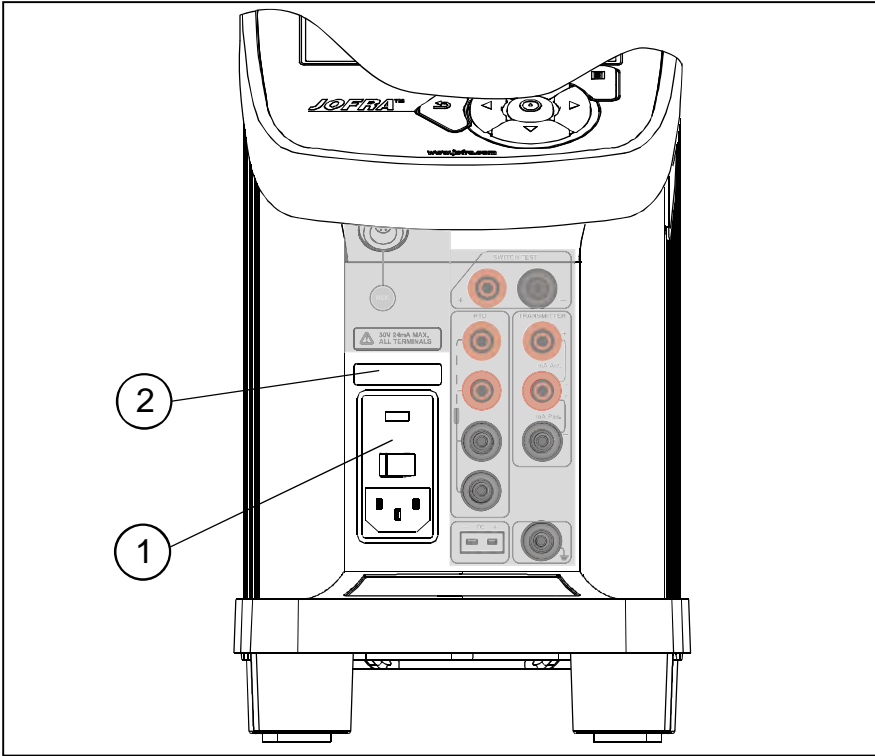

Fig. 4

Pos.	Description
1	Power control switch with a cable connection and on/off switch. It also contains the main fuse. See section 6.0 for information on how to change the fuses.
2	Label indicating fuse value

4.2 Input modules (B and C versions only)



Warning

- The input terminals must **NEVER** be connected to voltages exceeding 30V with reference to ground.

Description of sockets for external connections

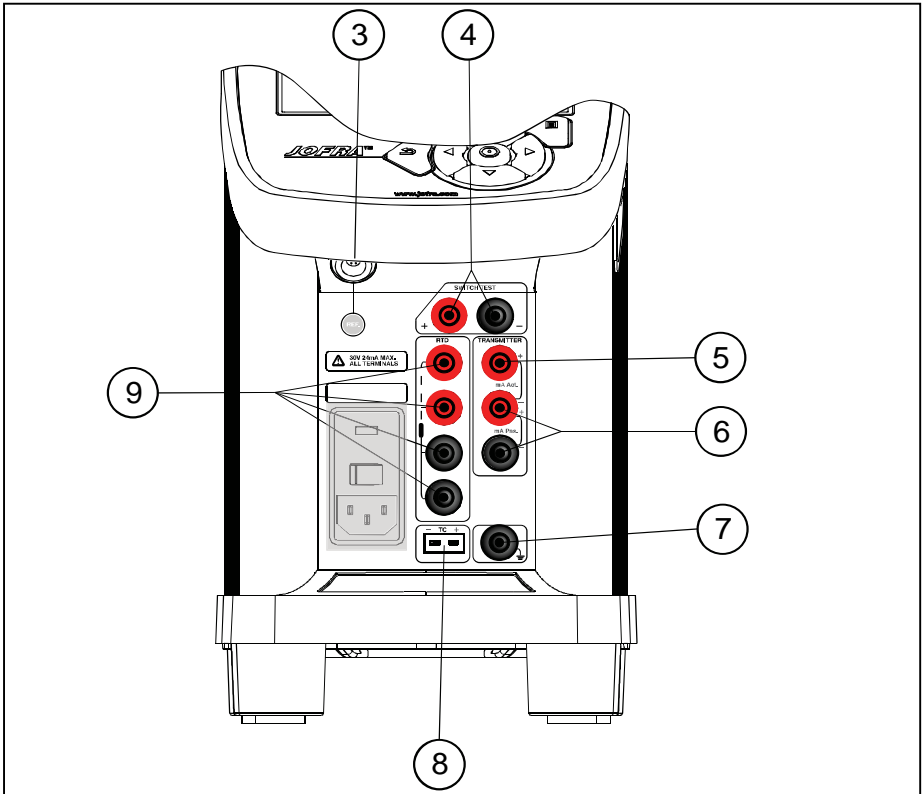

Fig. 5

Pos.	Description
3	Input for reference sensor (B and C versions)
4	Connection for thermostat switch test (B-version) Note that this connection is for voltage free switches

Pos.	Description
5	24V supply for active mA input (B-version)
6	Passive mA input (B-version)
7	Connection to chassis (earth/ground) (B-version)
8	TC connection for thermocouples (B-version)
9	Input for RTD sensor (2, 3 or 4 wire) (B-version)

One of the inputs either pos. **6**, **8** or **9** can be selected displaying the “SENSOR” temperature in the Setup and pos. **3** can be displayed as “TRUE” temperature.





Note: Only the sensor type, which is to be tested, should be connected to the input panel.

4.3 Keyboard and main screen display overview

Keyboard



Fig. 6

Keys	Description
	Full colour VGA display (main screen display information – see section 4.3.1)
	BACK KEY to cancel a selection/edit or return to previous menu.
	MENU KEY shows the vertical menu options listed. Can be displayed all through the process
	ARROW KEYS have different functions depending on the mode of operation. In navigation mode, they move the cursor in the desired direction. In edit mode they roll in the list of options or if entering a number, the ARROW left and ARROW right move the cursor one character in the desired direction

Keys	Description
○	<p>ACTION KEY and ENTER KEY</p> <p>ACTION KEY opens and closes edit fields or a menu button. The action key also accepts the selected option or entered value.</p> <p>ENTER KEY accepts selected options or entered values. When a value is entered with the ENTER KEY the cursor selects the next value field in the list.</p>

Main screen display

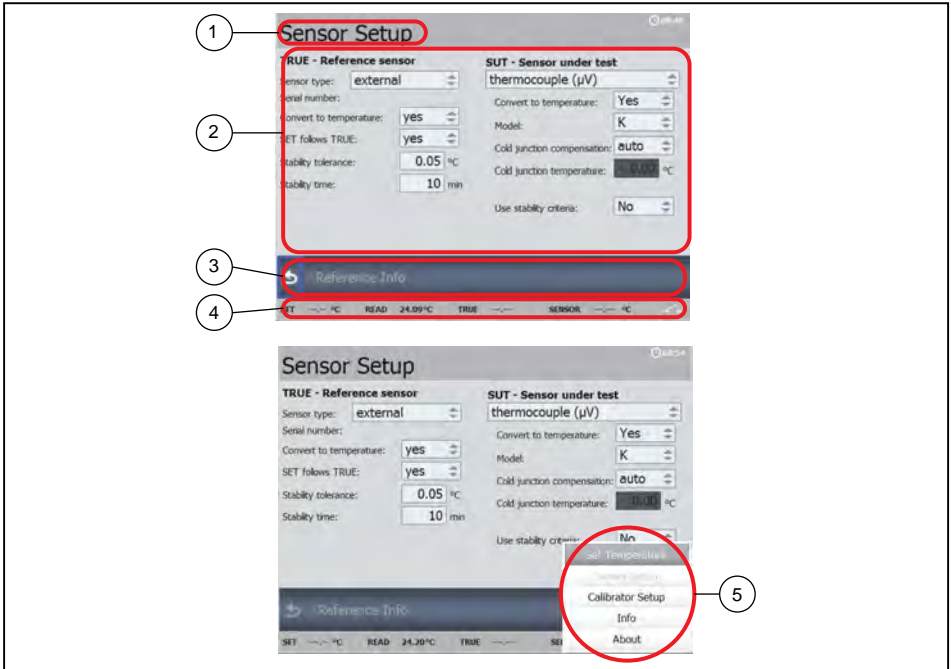

Fig. 7

The Main screen display is divided into four separate areas:

Pos.	Description
1	Heading: Informs you of the current menu selected.
2	Setup field: Provides the bulk of setup data in the menu. This data can be changed by moving the cursor to the various fields.
3	Horizontal menu: Provides you with the relevant menu options that can be selected at the present point. Each option can be activated either by selecting and activating the option – or simply by pressing the numeric key that corresponds to the option number.
4	Readings: This reading line is always visible and informs you of the current readings.

Pos.	Description
5	Vertical menu: This menu can be activated throughout the entire calibration. The menu can be switched on and off in all stages of operating the calibrator.

4.3.1 Main screen display information

The main screen gives an overview of the calibrator status and reads out the most relevant readings. In the Sensor Setup menu (see section 4.10) these readings can be changed.

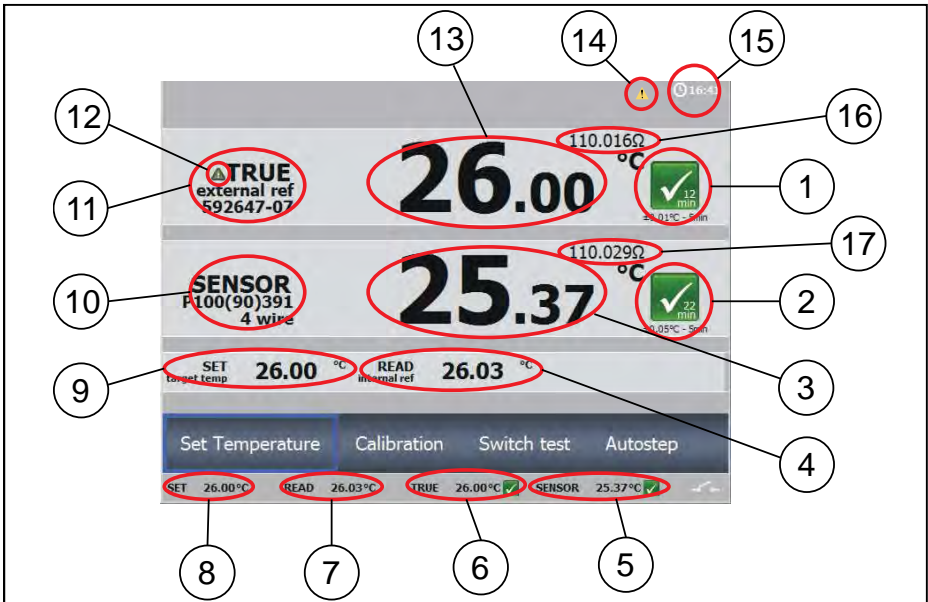

Fig. 8

Pos.	Description
1	Stability indicator displays the status of the True temperature stability. Yellow symbol indicates that stability is not yet obtained. A timer counts down. A green symbol indicates that the stability criteria are obtained and the time of stability is displayed. When time of stability is more than 99 min., the time is no longer displayed in the symbol, but only in the info screen (see section 4.12).

Pos.	Description
2	Sensor Under Test Stability indicator. If Sensor under Test stability criteria is selected, a symbol will indicate the stability of the sensor under test as well as the True sensor. When both Sensor Under Test and True sensor are stable, the calibrator is considered being stable.
3	SENSOR. Sensor Under Test value.
4	READ value. The internal reference is always displayed as READ value.
5	SENSOR value always visible.
6	TRUE value always visible.
7	READ value always visible.
8	SET reading always visible.
9	SET temperature.
10	Sensor Under Test Type.
11	Reference Sensor Info. The serial number of the external reference sensor is read from the intelligent reference sensor and displayed in this field.
12	Set follows True activated. The icon indicates, that the Set follows True function is active and will control the Temperature of the external reference sensor to the SET temperature.
13	True temperature reading. Can be either the internal reference sensor or an external reference sensor.
14	WARNING/ERROR symbol. The yellow icon indicates a warning. The red icon indicates an error. When the error symbol is displayed the calibration results cannot be saved. See section 6.1 for details concerning warnings and errors.
15	Real Time Clock display.
16	Resistance of external reference sensor when external reference sensor is selected as TRUE. (Optional)
17	Sensor under test value in ohm/mV/mA. (Optional)

4.3.2 Main screen temperature values

Two temperatures are always displayed:

- **TRUE temperature:** This is the reference temperature of the calibrator. In the A-version this is always the internal reference sensor. In B- and C-versions the TRUE temperature can either be the internal reference or the external reference.
- **SET temperature:** This is the target temperature for the well. SET temperature displays the last value entered. If no value has been entered previously, "---,--" is displayed.

Additional temperatures displayed (B versions only):





- **SENSOR temperature:** This is the temperature measured by the sensor under test (SUT).

Additional temperatures displayed (B and C versions only):

- **Ext. TRUE temperature:** This is the temperature measured by an external reference sensor. This is only displayed when an external reference sensor is used and replaces the internal reference.

4.3.3 Stability of temperature values

The stability of the TRUE and SENSOR temperatures are indicated by the following messages:

-  : "Not stable": Indicates that the measured temperature is not yet within the specified stability criteria.
 -  : Indicates "Time to stable": The temperature changes are within the specified stability criteria (see chapter 8.0) and states a time (in minutes and seconds) when the stable situation can be achieved.
 -  : Indicates that the "stable" situation is achieved.
-  • If External reference is selected as TRUE, the stability criteria will refer to this.

The criteria can be changed, however, if the temperature stability criteria is set wider or the stability time is set shorter, the calibrator may not reach the SET temperature.

- If “Use stability criteria” is set to “Yes” for the SENSOR, the automatic calibration function will continue to next temperature step only when both TRUE and SENSOR indicate stability.

4.4 Operating principle

The calibrator is operated using the horizontal and the vertical menu list.



The  (ACTION/ENTER key) is used for selecting and activating the menus and functions and for accessing various parameters in setup fields.

The  (ARROW keys) are used to move from menu item to menu item in the menu lists, to access various result lists, to scroll through various lists and to access setup fields.

4.4.1 Horizontal Menu

The horizontal menu options apply to the displayed screen. It is dynamically giving the relevant choices during operation. The menu functions are activated in the following way:



Move the blue cursor with the ARROW key  to mark the menu button on the screen. Then press  to activate the selection.

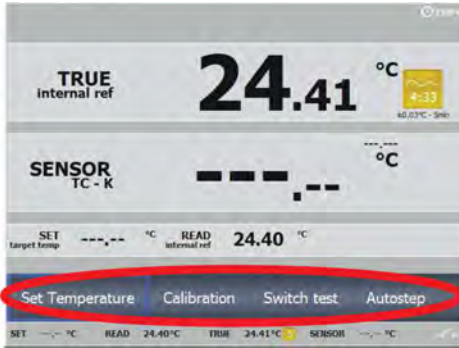

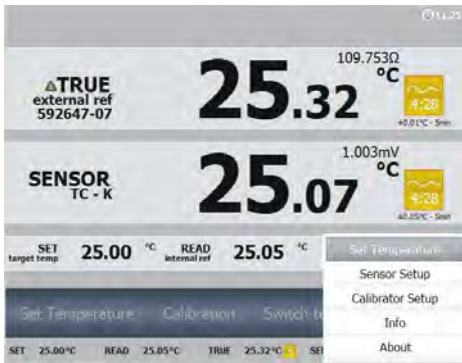

4.4.2 Vertical Menu

The vertical menu list can be called at any stage of operation making it possible to jump to the desired menu.



This allows you to jump to the most used menu easily - no matter where you are.



Press the  button to access the menu. To exit the menu, press the button again or  (BACK).

This menu always gives the same options, however at some points some choices are not relevant and will therefore be shaded, i.e. you can not set a temperature, when an Auto step procedure is running.

To activate the menu functions:



Move the cursor with the ARROW keys ▼ or ▲ to mark the menu field on the screen. Then press  to activate the selection.



4.4.3 Parameter Fields

The setup menus have fields for parameter entries. When the setup is entered, then focus will be on the horizontal menu, and the function here can be activated.

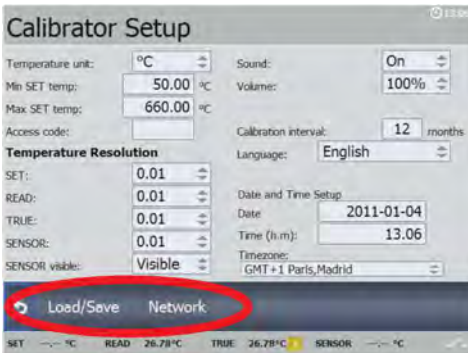



By pressing the ARROW UP key ▲ focus will move from the horizontal menu to the parameter field area.

The parameter field area focus is indicated by

- The horizontal menu is now shaded
- The selected parameter field is highlighted with a dark grey colour

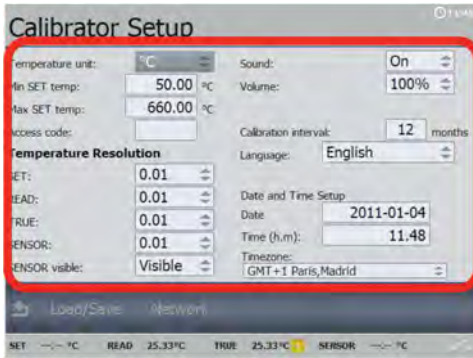

Use the 4 ARROW keys to move between the parameter fields.

A parameter value is changed by:



- Pressing  to open the field for editing.



- Press one of the 2 ARROW keys ◀ or ▶ to move between the numeric fields.



- Enter a numeric field by pressing either ▲ or ▼.

When the parameter is entered press the key:



- This enters the value and leaves the cursor on the parameter field.

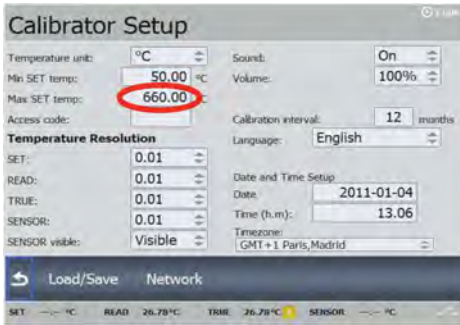

4.4.4 Working with lists

When it is possible to choose between a number of data sets, the data sets are presented in lists.



As an example access the Calibrator Setup menu from the vertical menu and activate “Load/Save”
A list of instruments settings will be displayed.

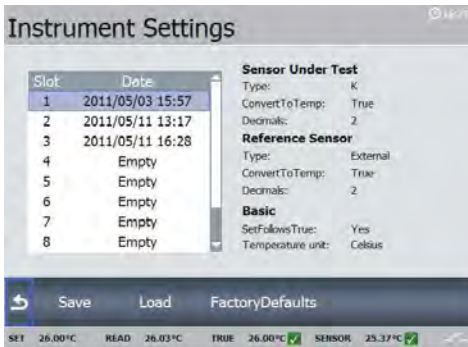



Press ARROW UP ▲ to move the focus from the horizontal menu to the list.

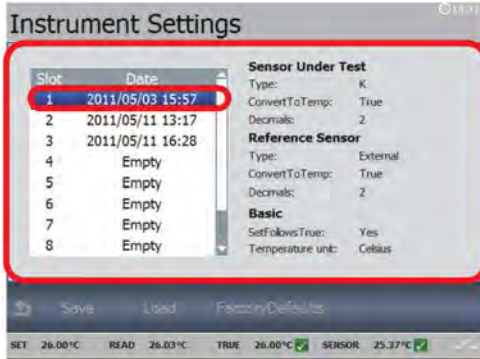

The selected data set in the list is now highlighted with a dark blue color.



Scrolling in the list is done using the ARROW UP key ▲ and the ARROW DOWN key ▼.

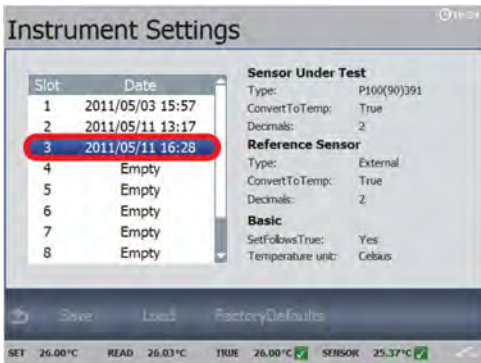



When the desired dataset in the list is highlighted press .

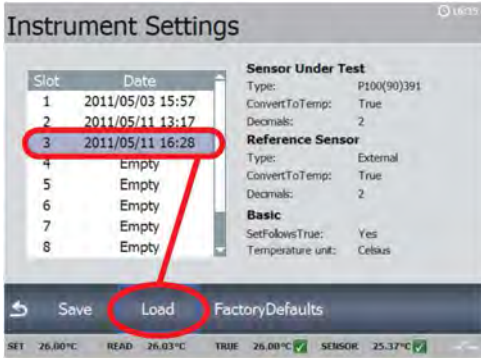

Now the horizontal menu will be in focus again and here you are able to decide what to do with the chosen dataset.

Activate the desired function in the horizontal menu. In this example the Instrument Settings from 2011/05/11 16:28 will be loaded from the memory into the active setup.

Some lists have no horizontal menus and only one option available.



As an example access the Switch test menu by selecting “Switch test” from the main menu and then activate “Results”.

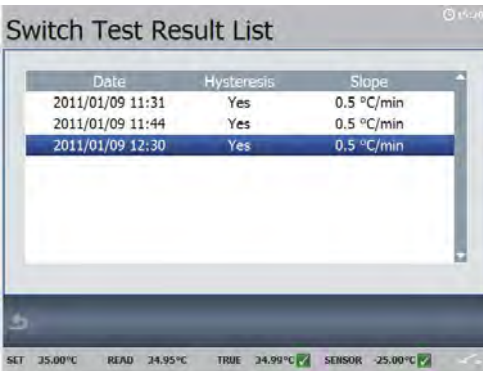

Scroll through the list using the ARROW UP key ▲ and the ARROW DOWN key ▼ and just press  to display the result of the highlighted dataset.

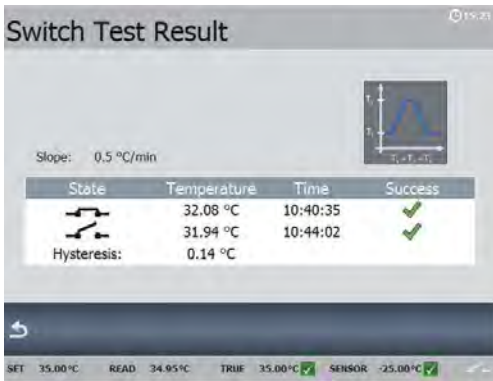

4.5 Starting the calibrator

Switch on the calibrator using the power control switch (pos. 1, fig. 5). A start up screen is displayed and then replaced with the main menu screen:

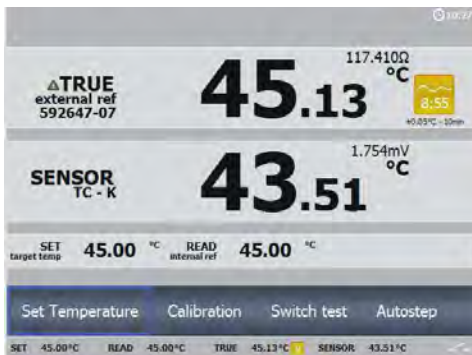



The functions in the horizontal menu are available using the ARROW keys on the keyboard (see description in section 4.3).

4.6 Setting the temperature

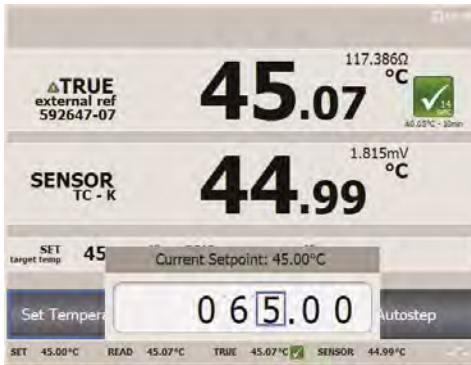

Access the Set Temperature function by selecting “Set Temperature”.



Use the ARROW keys to enter a new value, and  to accept the value and return to the main menu screen. If pressing the BACK key the calibrator returns to the main menu screen without accepting the new value.

The Set temperature function can also be accessed using the vertical menu (press ). Through this menu a new set point value can be entered at any stage of the operation **except when one of the automatic functions is active.**

4.7 Calibration (optional)



Note...

This Calibration function is for B versions only.

This function enables you to perform automatic calibrations of different temperature sensors. The calibration procedure is semi-automatic, using parameters and settings, which are defined in workorders. These workorders are created and edited using the "JOFRACAL" PC program. Multiple calibrations can be performed using the same workorder settings.



Access the Calibration menu by selecting “Calibration” from the main menu.



A Workorder List is displayed.



Run the selected workorder by activating “Run “. A new calibration is started.

You can also chose to activate:

“View” – shows the setting of the workorder.

“Results” – shows the previous calibration results from this workorder.

“Delete” – deletes the workorder setting and the results.

For operating the Results menu see section 4.7.2.

For operating the View menu see section 4.7.3.

For operating the Delete function see section 4.7.4.



Note...

Calibration information is available in several places throughout the calibration menus. The content of this information is described in section 4.7.3.

4.7.1 Running a calibration



To run the calibration, select “Run” from the Workorder List menu.

If the serial number of the reference sensor used for calibration does not match the one specified in the workorder the following message is displayed :



If you proceed, the connected reference sensor will be documented along with the results.

If you do not wish this message to appear, the correct reference sensor must be specified when the workorder is edited using the “JOFRACAL” PC program.



Choose “YES” and press  if you want to proceed with the calibration.

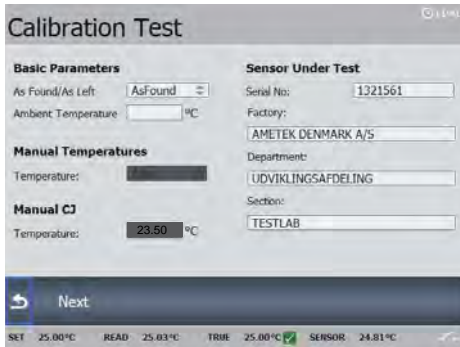

The Parameter setup menu is displayed.

Note...



If the sensor under test is a thermocouple sensor and the manual compensation mode is selected in work orders, a cold junction temperature must be defined.

The parameters in the workorder can be edited.

Note...



- Only numeric data can be entered.
- The BACK key  cancels a selection/edit or returning to previous menu. The ESC key can be used throughout the process.



Select “Next “ to proceed with the operation.

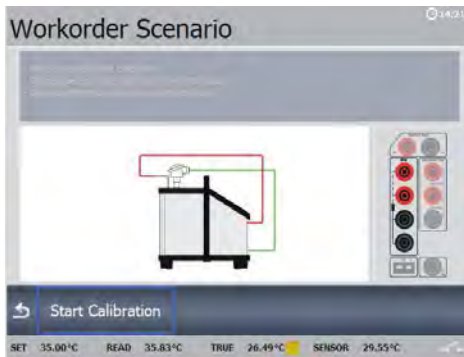

A workorder Scenario is displayed, giving a graphical display of the setup and sensor connections.



Start the calibration by selecting “Start Calibration”.

The Calibration Running step 1 of 2 is started and the temperature is heading towards step 1.

The following screen is displayed :

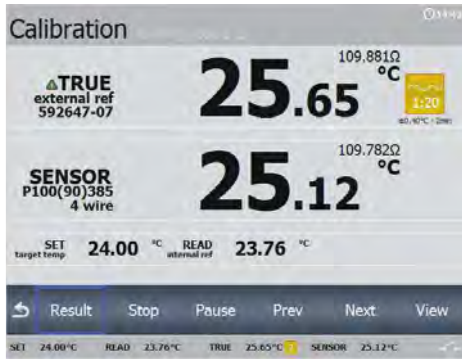

When the temperature has reached the stable criteria, the calibration data will be stored and the temperature goes towards the next set temperature.

If the workorder contains manual reading during calibration, you will be asked to enter the Sensor Under Test temperature before that.

The following screen is displayed :

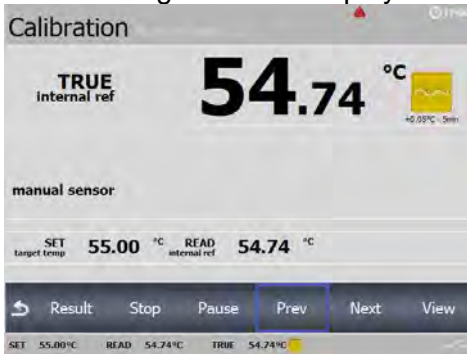

If manual readings are specified these will have to be entered before next step starts.



Note...

The calibration can be stopped at any time by activating "Stop", but this will erase the calibration results.

During calibration several other functions are available:

- “Result” - To view the calibration results (no editing is possible).
- “Pause” - To pause the calibration.
- “Prev” - Force the calibration to jump a step backwards to the previous calibration screen regardless of the calibration stability.
- “Next” - Force the calibration to jump a step forwards to the next calibration screen regardless of the calibration stability. This will leave the current step without saving calibration results.
- “View” - To view the workorder settings.

When the calibration has completed a green check ✓ is shown on the screen and the Calibration Result follows quickly hereafter.

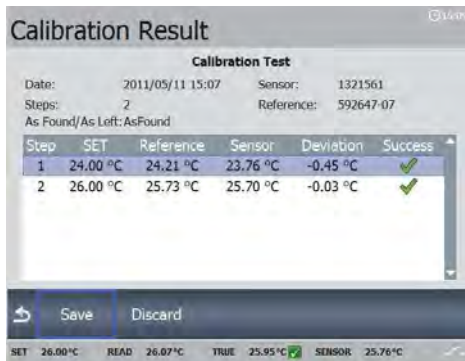

Select “Save” to store the results in the calibrator

or



select “Discard” and press “Yes” to delete the calibration results or “No” to return to the Calibration Result screen.

A full Calibration Result List can be viewed using the instructions in section 4.7.2.

4.7.2 Viewing calibration results



Access the Calibration Result function by selecting “Results” from the Workorder List menu.

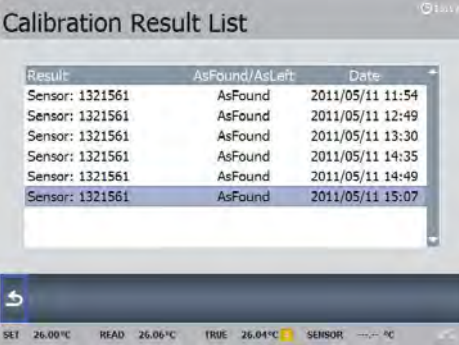

The screenshot shows a screen titled "Calibration Result List". It contains a table with three columns: "Result", "AsFound/AsLeft", and "Date". The table lists five entries for sensor 1321561, all with "AsFound" results and dates from 2011/05/11. Below the table is a navigation bar with a left arrow icon. At the bottom of the screen, there is a status bar showing "SET 26.00 °C", "READ 26.06 °C", "TRUE 26.04 °C", and "SENSOR --- °C".

Result	AsFound/AsLeft	Date
Sensor: 1321561	AsFound	2011/05/11 11:54
Sensor: 1321561	AsFound	2011/05/11 12:49
Sensor: 1321561	AsFound	2011/05/11 13:30
Sensor: 1321561	AsFound	2011/05/11 14:35
Sensor: 1321561	AsFound	2011/05/11 14:49
Sensor: 1321561	AsFound	2011/05/11 15:07

A full Calibration Result List is displayed.



Select a workorder to be displayed showing the calibration details for the specific workorder.

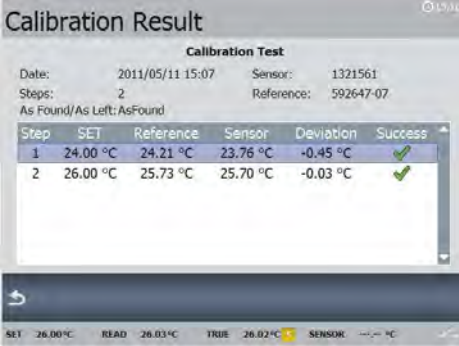

The screenshot shows a screen titled "Calibration Result". It displays "Calibration Test" details for a specific workorder. The date is 2011/05/11 15:07, sensor is 1321561, and reference is 592647-07. The "As Found/As Left" is "AsFound". Below this is a table with columns: "Step", "SET", "Reference", "Sensor", "Deviation", and "Success". Two steps are listed, both successful. At the bottom, there is a navigation bar with a left arrow icon and a status bar showing "SET 26.00 °C", "READ 26.03 °C", "TRUE 26.02 °C", and "SENSOR --- °C".

Step	SET	Reference	Sensor	Deviation	Success
1	24.00 °C	24.21 °C	23.76 °C	-0.45 °C	✓
2	26.00 °C	25.73 °C	25.70 °C	-0.03 °C	✓



The calibration results can be uploaded with the “JOFRACAL” PC program. This enables you to print out the results on a certificate.



Press  to exit the Calibration Result List and return to the Workorder List menu.

4.7.3 Displaying calibration information

Calibration information is defined within the work orders created on the PC using "JOFRACAL".



Access the Workorder Sensors menu by selecting "View" from the Workorder List menu.



The Workorder Sensors menu is displayed.

This screen gives you an overview of the workorder sensor setup including a summary of Notes, Scenario and Steps. Each of these can be displayed in details



Select "Notes" to access the Notes function.

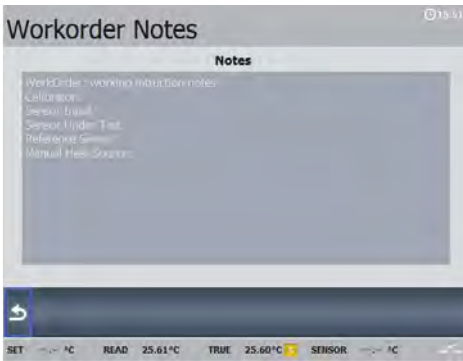

A list of Workorder Notes is displayed.

The notes are information entered via the PC program, when the workorder is created.

☞ Press  to exit the Workorder Notes screen.

☞ Select “Scenario” to access the Scenario function.

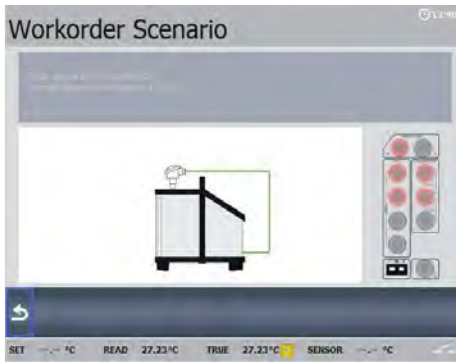

A Workorder Scenario is displayed.

The calibration set up is shown in a graphic format, and the active sensor input is marked. The parameters for this setup are defined in the work order created using the PC program.

☞ Press  to exit the Workorder Scenario screen.

☞ Select “Steps” to access the Step function.

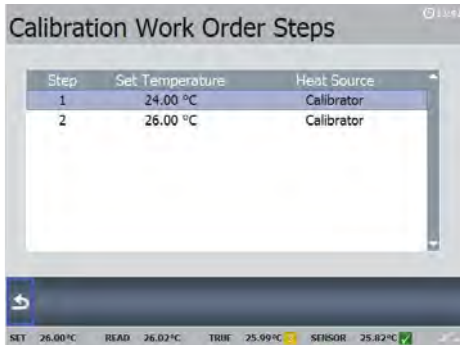

A list of Temperature Steps is displayed.

This function shows the pre-defined temperature steps for the calibration.

☞ Press  to exit the Step function and return to the Workorder Sensors menu.

4.7.4 Deleting workorders

It is possible to delete a workorder using the Delete function from the Workorder List menu.



Select “Delete” to access the Delete function.

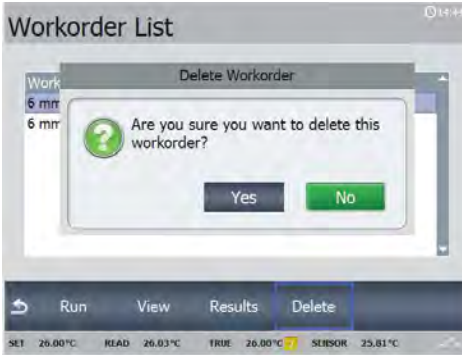

Press “Yes” if you want to delete your workorders and “No” if you want to exit the Delete function without deleting anything.



Warning

If you choose to delete a workorder, the whole workorder including the calibration results will be deleted.



Press  to exit the Workorder List menu and return to the main menu.

4.8 Switch test menu



Note...

This Switch test function is for B versions only.

Switch test automatically locates the switch temperatures of a thermostat.

Three parameters are required:

- Start temperature (T_1)
- End temperature (T_2)
- Rate of change in temperature (slope rate).

Hysteresis of a thermostat can also be determined here. Where the hysteresis determines the tolerance between the upper switch temperature and the lower switch temperature of the thermostat.

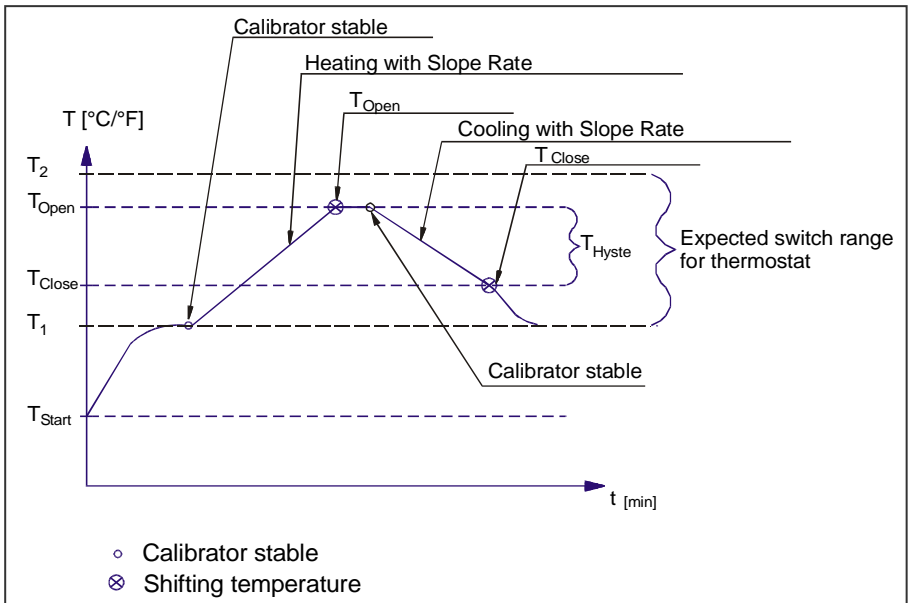
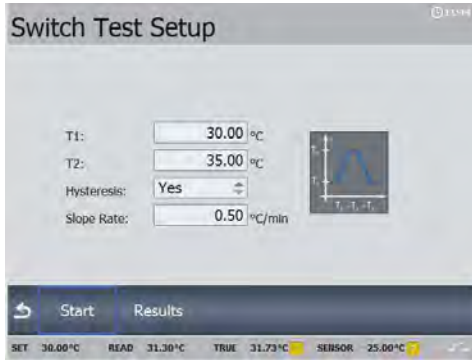

Fig. 9

4.8.1 Running a switch test



Access the Switch test menu by selecting “Switch test” from the main menu.



A Switch test setup menu is displayed.

The small graph illustrates the current T_1 , T_2 and hysteresis selections. Note that T_1 can be greater than T_2 .



Access the setup field to edit the parameters:

- T_1 - first set temperature
- T_2 - second set temperature
- Hysteresis - to determine hysteresis, toggle between "Yes" (a two-way-temperature measurement) and "No" (a one-way-temperature measurement).
- Slope rate - The permitted range is 0.1 - 9.9°C/min. / 0.2 - 17.8°F/min.



Note...

the slope rate should be set so that the thermostat sensor can follow the temperature in the calibrator's well.



Press  to exit the setup function and return to the Switch test setup menu.

Before starting the switch test ensure that the switch is connected to the switch input (see page 25, pos. 4).



Select “Start” to start the switch test.



The Switch Test is now in progress.

While the switch test is in progress, 2 options are available:

- “Result” – displaying the current switch test results.
- “Stop” – stopping the switch test. Press “Yes” to stop the switch test and “No” to return to the Switch Test screen.

The calibrator's switch test procedure

1. Once the switch test is started, the calibrator starts working towards T_1 as quickly as possible. The calibrator's temperature changes (heating or cooling) and switch status are shown in the display.
2. When T_1 is achieved and the temperature is stable, the text and the graphic in the middle of the screen will change accordingly.
3. The calibrator now starts working towards T_2 at the specified slope rate.
4. In a normal situation, the thermostat changes state before T_2 is achieved. If T_2 is achieved and the temperature is stable, a red cross will be displayed instead of a green check ✓.
5. When hysteresis is not selected (single temperature change) (the graphic indicates the choice), the finished switch test result is displayed.

When hysteresis is selected (two switch changes), the calibrator starts working towards T_1 at the specified slope rate.

6. Normally, the thermostat changes state before T_1 is achieved. If T_1 is reached and the temperature is stable, a red cross will be displayed instead of a green check ✓.
7. The finished switch test results are displayed.

4.8.2 Showing switch test results

Two types of switch test results are available:

- Results during a switch test.
- Results of a finished switch test.

Results during a switch test



Access the Switch Test Result List by selecting “Result” from the Switch Test menu.



This shows the results that are currently available. These results change as the test progresses.



Press to return to the switch test.

Finished switch test results

At the end of a switch test the results are displayed. These show the temperature when the thermostat has closed and the temperature when it has opened – whichever comes first. The difference between these 2 temperatures is calculated as the hysteresis.



Select “Save” to save the results storing them in the calibrator’s memory.



Select “Discard” to delete the results from the screen.



Note...

A hysteresis result is only measured when hysteresis is set to “Yes”.

You will then automatically return to the Switchtest setup menu.

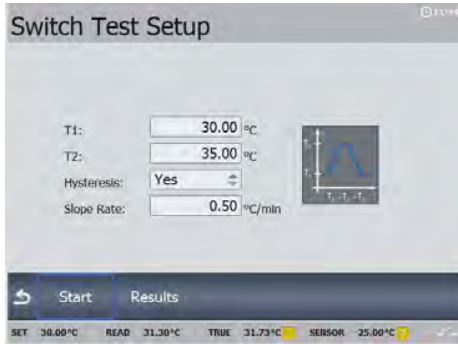

If no change in the switch position is registered during the test a red cross will be displayed in the Result list instead of a green check ✓.



Delete the result by selecting “Discard” or save the result by selecting “Save”.

To view stored switch test results



Access the Switch Test Result List by selecting “Results” from the Switch test setup menu.

Date	Hysteresis	Slope
2011/01/09 11:31	Yes	0.5 °C/min
2011/01/09 11:44	Yes	0.5 °C/min
2011/01/09 12:30	Yes	0.5 °C/min

SET 35.00°C READ 34.95°C TRUE 34.99°C SENSOR -25.00°C



Select a test result to be displayed.

Slope: 0.5 °C/min

State	Temperature	Time	Success
	32.08 °C	10:40:35	✓
	31.94 °C	10:44:02	✓

Hysteresis: 0.14 °C

SET 35.00°C READ 34.95°C TRUE 35.00°C SENSOR 25.00°C



Press  twice to return to the Switch test setup menu.

4.9 Auto step menu

Auto step is used to step automatically between a range of different calibration temperatures. This is useful when calibrating sensors in places that are difficult to reach and sensors where the output is displayed in a different location.

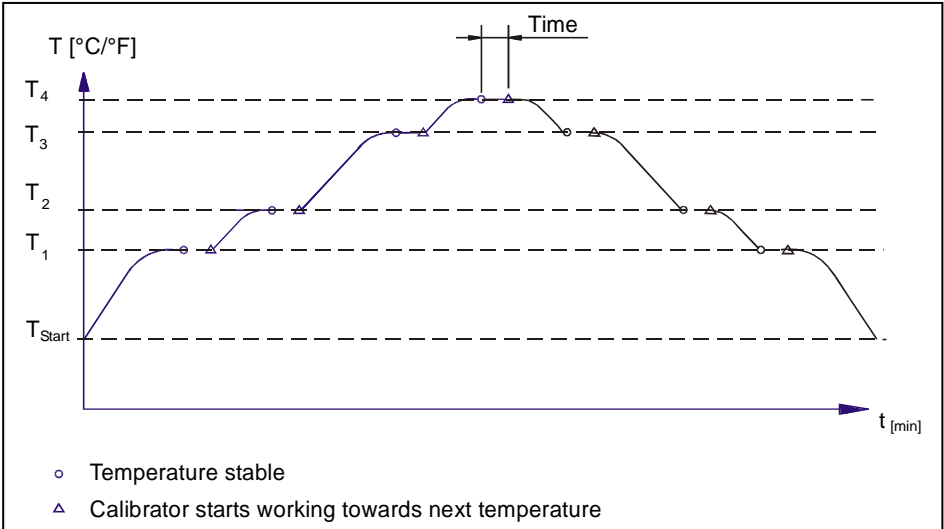

Fig. 10

4.9.1 Running an Auto step calibration



Access the Auto Step Setup menu by selecting “Autostep” from the main menu.



The Auto Step Setup menu is displayed.



Access the Auto Step Setup to edit the parameters:

- **No of steps:** the number of temperature steps per direction ($T_1 \rightarrow T_x$) can be set using integers from 1 – 20. When a Two-way mode is selected, the same number of steps are used for the second direction ($T_x \rightarrow T_1$).
- **Mode:** toggle between “One-way” and “Two-way”.
- **Hold time:** defines the time (in minutes) the temperature is maintained (after it is stable) for each step.
- **T step values:** must be set within the sensors permitted range.



Press  to exit the editor and return to the Auto Step setup menu.



Access the Sensor setup menu by selecting “Next ” from the Auto Step Setup menu.

Sensor Setup

TRUE - Reference sensor

Sensor type: external

Serial number: 592647-07

Convert to temperature: yes

SET follows TRUE: yes

Stability tolerance: 0.05 °C

Stability time: 10 min

SUT - Sensor under test

thermocouple (µV)

Convert to temperature: Yes

Mode: K

Cold junction compensation: auto

Cold junction temperature: 23.00 °C

Use stability criteria: No

Reference Info Start

SET 45.00°C READ 44.90°C TRUE 44.95°C ✓ SENSOR 44.92°C

The Sensor setup menu is displayed. In this menu you have the opportunity to check and if necessary change the settings as described in section 4.10 – Sensor Setup menu.



Select “Start” to start the Auto Step calibration.



An Auto Step Running step screen is displayed.

While the step test is in progress, several functions are available:

- “Result” - To review the Auto Step results (no editing is possible).
- “Stop” - To stop the Auto Step test.
- “Pause” - To pause the test.
- “Prev” - Force the test to jump a step backwards to the previous running step regardless of the step’s stability.
- “Next” - Force the test to jump a step forwards to the next running step regardless of the step’s stability.

When the Auto Step test is complete the results are displayed.



AutoStep Result

AutoStep Test

Date: 2011/01/05 12:18
Steps: 3

Step	SET	Reference	Sensor	Deviation	Success
1	45.00 °C	44.96 °C	44.94 °C	-0.02 °C	✓
2	55.00 °C	55.05 °C	55.02 °C	-0.03 °C	✓
3	65.00 °C	65.11 °C	65.01 °C	-0.10 °C	✓

Save Discard

SET 63.00 °C READ 64.98 °C TRUE 63.03 °C ✓ SENSOR 64.98 °C



Select “Save” to save the results storing them in the calibrator’s memory.



Select “Discard” to delete the results from the screen.
The calibrator then returns to the Auto Step Setup menu.

4.9.2 Auto Step test results

At the end of an Auto Step test the results are displayed and stored in the calibrators memory.

The measured TRUE and SENSOR temperatures for each step are displayed.

To view stored Auto step test results



Access the Auto Step Result List by selecting “Results” from the Auto Step Setup menu.

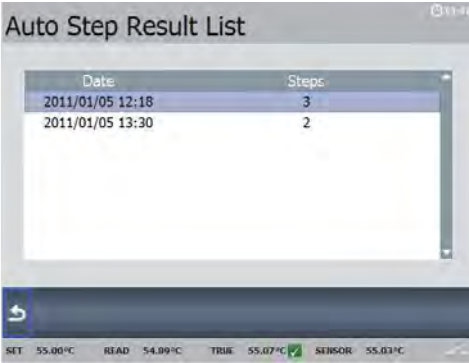

The Auto Step Result List is displayed.



Select an auto step result to be displayed.



Press  twice to return to the Auto Step Setup menu.

4.10 Sensor Setup menu



The Sensor Setup can be entered through the vertical menu (press )

The Sensor Setup can also be edited immediately before running the Auto step (section 4.9.1) or when starting a switch test.

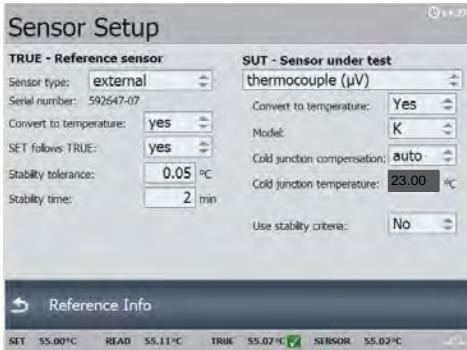

Activate “Sensor Setup”.

4.10.1 Setting the additional stability time (A version)



Set the additional stability time by pressing  and the ARROW keys. Stability time can be set (in minutes) using integers from 0 – 99.



4.10.2 Setting the parameters for TRUE – reference sensor (B and C versions only)

Sensor type:

Internal reference source.

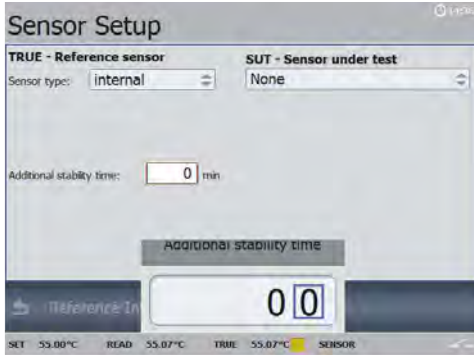

The internal reference sensor will be displayed as the TRUE value on the main screen.

The calibrator has a set of internal stability criteria it shall meet before stability is indicated. Additional stability time may be set beyond the internal stability criteria.



Set the additional stability time by pressing  and the ARROW keys. Stability time can be set (in minutes) using integers from 0 – 99.

External reference source

The TRUE value on the main screen will be read from the Intelligent Reference Sensor connected to the REF. INPUT on the front panel (see section 4.2 fig. 5). The calibrator automatically reads the calibration data and serial number of the Sensor.

Convert to temperature:

- “yes” sets the readout of the External reference as a temperature.
- “no” sets the readout of the External reference in Ω values.

SET follows TRUE:

This function enables you to reach the TRUE temperature measured by the External reference sensor.



Note...

that when “yes” is selected, the calibrator will control the temperature to the TRUE temperature. This means that it could take longer time before the calibrator indicates stability.

The “SET follows TRUE” function is indicated with the symbol  at the TRUE reading in the main display.



Note...

SET follows TRUE is only relevant when the External reference sensor is displayed in temperature units.

Stability tolerance:

The Stability tolerance can be set down to $\pm 0.01^\circ$. The tolerance should be set low enough to utilize the good temperature stability of the calibrator – however a low value also gives a longer time to be stable.

Stability time:

Stability time can be set from 1 – 99 minutes.

When the TRUE temperature has reached the specified Stability tolerance during the specified Stability time, then the stability indicator in the main screen will turn green.



Press  to accept the new setting(s) and return to the Sensor setup menu or continue to edit the Sensor under test parameters.

4.10.3 Setting the parameters for SUT– Sensor under test (B versions only)

Sensor type:



Choose between :

- thermocouple sensors (μV)
- current (mA) sensors
- RTD sensors (resistance temp. detector (Ω))
- None (no sensor connected)



Select a sensor.

The selected sensor and its list of parameters are now displayed. The various settings can be edited as described in the following :

Convert to temperature:

(using thermocouple, current and RTD)

- “yes” – the inputs are converted to temperatures.
- “no” – no conversion is made.
When “no” has been selected the type of model is the only other parameter which can be altered.

Model:

(using thermocouple and RTD)



Toggle between the models; K, L, N, R, S, T, U, B, E and J (thermocouple) or *P10(90)385, *P50(90)385, P100(90)385, *P200(90)385, *P500(90)385, P1000(90)385, *P50(90)391, P100(90)391, P100(90)392, *Pt-100 MILL, *YSI-400, H120(90)672, *M100(90)428... and *M50(90)428 (RTD).

* Optional

Cold junction compensation:

(using thermocouple)

- “auto” – when the automatic mode is selected, the calibrator measures the temperature in the T/C connector and uses this for the cold junction compensation of the thermocouple.

- “manual” – to define a manual temperature for cold junction compensation. Can be used when an external cold junction temperature can be established.

Cold junction temperature:

(using thermocouple)



When “manual” Cold junction compensation has been selected the temperature for cold junction can be set using the ARROW keys.

Current(C) and temperature(T) span:

(using current)

The minimum and the maximum of the current and the corresponding temperature span can be set here.



Use the ARROW keys to set the value of the current and/or the temperature.

Number of wires:

(using RTD)

The number of wires used for the sensor under test can be selected here.



Choose between 2, 3 or 4 wires.

Use stability criteria:

(using thermocouple, current and RTD)

Beside the stability check on the Reference sensor, it is also possible to ensure that the Sensor Under Test (SENSOR) is stable before the temperature is indicated as stable.

- “yes” – Stability will be checked on both Reference sensor (TRUE) temperature and Sensor Under Test (SENSOR) temperature.
- “no” – Stability will be checked on Reference sensor (TRUE) temperature only.

Stability tolerance:

(using thermocouple, current and RTD)



Enter the Stability tolerance (temperature) by pressing the ARROW keys.

The Stability tolerance can be set down to $\pm 0.001^\circ$ however the expected performance of the Sensor Under Test should be considered before setting the tolerance.

Stability time:

(using thermocouple, current and RTD)



Set the Stability time by pressing the ARROW keys. Stability time can be set from 1 – 99 minutes.

When the SENSOR temperature has reached the specified Stability tolerance during the specified Stability time, then the stability indicator in the main screen will turn green.

4.10.4 Viewing the Reference data (B and C versions only)

The calibration data of the Intelligent Reference sensor can be viewed using the Reference Info function from the Sensor setup menu.



View the Reference Info box by selecting “Reference Info”.

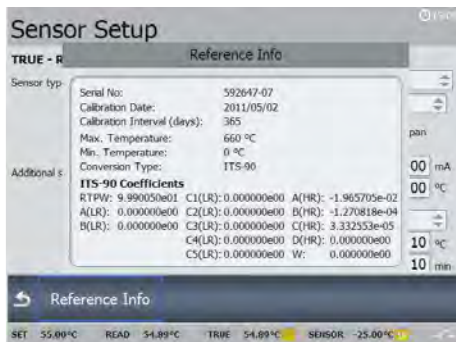

The Reference Info box is displayed.



Press  to return to the Sensor setup menu.

4.11 Calibrator Setup menu



The Calibration Setup can be edited through the vertical menu (press **≡**).

Calibrator Setup

Temperature unit: °C Sound: On
Min SET temp: 45.00 °C Volume: 100%
Max SET temp: 660.00 °C
Access code: Calibration interval: 12 months
Language: English

Temperature Resolution

SET: 0.01
READ: 0.01
TRUE: 0.01
SENSOR: 0.01
SENSOR visible: Visible

Date and Time Setup
Date: 2011-01-05
Time (h.m): 11.12
Timezone: GMT+1 Paris, Madrid

Load/Save Network

SET -45.00°C READ 44.02°C TRUE -44.96°C SENSOR -44.92°C



Activate “Calibrator Setup”.

4.11.1 Setting the temperature parameters

Temperature unit:



Choose between:

- °C (Celsius)
- °F (Fahrenheit)
- K (Kelvin)

Min SET temp / Max SET temp:



Enter the access code to get access to the editor.



Use the ARROW keys to set the Min/Max SET temperature in Celsius, Fahrenheit or Kelvin.



Note...

The Enter Access Code box is displayed every time you try to access the Min/Max SET temp parameters. Type in your access code and continue.

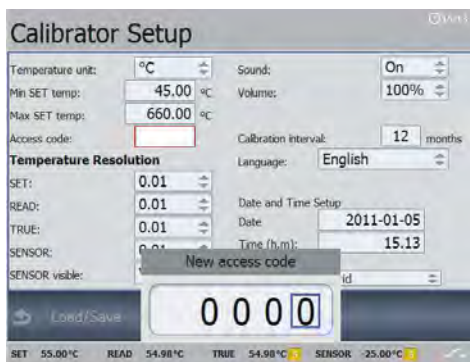

Access code:

The following features can be protected by an access code:

- Resetting the calibrator to Factory default settings.
- Setting the Min/Max SET Temperature.
- Editing the Access code while it is enabled.



Press  to access the Access code function.



Use the ARROW keys to type in a value from 0000 to 9999. Use all 4 digits.

Typing 0000 disables the Access code function.

The access code is accepted showing a green check ✓ for a few seconds allowing you to continue.



Caution...

If you choose to let your access code consist of only 1, 2 or 3 digits you must enter the access code with 0 followed by the chosen value.

Example:



The access code 12 is selected.



Type in 0012 in the Enter Access Code box



Note...

The access code can be deleted allowing you to change the Min/Max SET temperature without having to enter the access code.



Press  to access the Access code function.

Type in your access code.



No new value is entered.

Accept the new setting (empty box).

It is now possible to enter the editor without using the access code.

4.11.2 Setting the temperature resolution



Choose between :

- SET
- READ
- TRUE
- SENSOR



Choose between the resolutions:

- 0.01
- 0.1
- 1

SENSOR visible:



Choose between :

- Visible
- Hidden

If the Hidden option is chosen the Sensor Under Test reading will not be displayed on the main screen.

4.11.3 Setting the sound and volume

Sound:



Choose between :

- On
- Off

Enables the calibrator to make a sound during operation. Sound responses are given at the following conditions:

- Stability
- Warnings
- Accept of data entry
- Reject of data entry

Volume:



The volume of the sound can be adjusted from 0 – 100%.

4.11.4 Setting calibration interval

Sets the required recalibration interval for the calibrator.



Choose a value between 1 month and 99 months.

When the recalibration interval is exceeded, the warning symbol will appear in the display.



Note...

The recalibration interval is not used for the external reference sensor. The interval for these sensors are stored in the intelligent sensor.

4.11.5 Choosing a language (optional)

The calibrator is set up with a default language - English.

Use the ARROW keys to select the relevant language from a list of various languages.

4.11.6 Changing the date and time

Date:



Use the ARROW keys to enter a new date.

The date can only be entered using the format yyyy-mm-dd. When entering the date with different format, the text will disappear when you try to accept the setting.

Time:

The calibrator is set up with a default time (present time).



Use the ARROW keys to enter a new time using the format hh.mm.

Time Zone:



The relevant time zone is selected from a list of various zones.

4.11.7 Saving a setup

Saving a setup saves parameters in the Setup menu.



Access the Instrument Settings menu by selecting “Load/Save” from the Calibrator Setup menu.

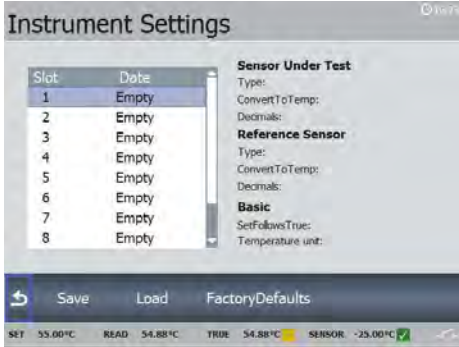

The Instrument Settings are displayed.



Select a register number to be used for saving.

The setup will be saved with the selected register number.



Note...

In the Calibrator Setup the following parameters will not be saved:

- Min SET temp
- Max SET temp
- SENSOR visible

You can save up to 10 setups.

When the setup is saved the parameters are visible in the right side of the screen.



4.11.8 Loading a setup

Loading a setup causes the setup parameters to be overwritten.



Select a setup from the list to be loaded.

The selected setup will be loaded into the calibrator's memory.



Press  to return to the Calibrator setup menu.

4.11.9 Resetting the instrument setup to factory defaults

Resetting to the factory default settings changes the active setup to the initial settings.

4.11.10 Network Configuration (for service use only)



Access the Network Configuration function by selecting “Network” from the Calibration Setup menu.

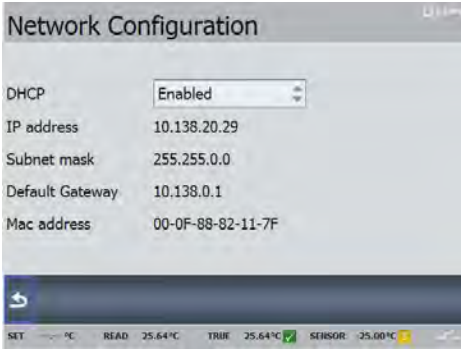

The Network Configuration screen is displayed.

When DHCP is set to Enabled, the IP address will be updated when leaving the network menu.

When DHCP is disabled, you can configure the IP-settings manually using the ARROW keys.

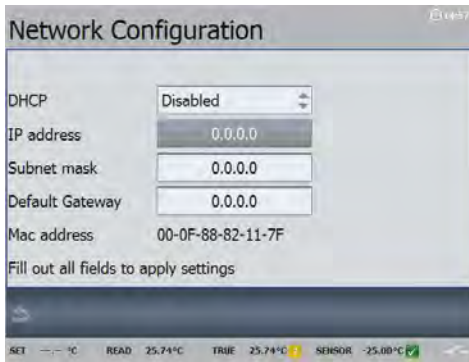

4.12 Information Screen



Information about the status can be viewed using the Info function from the vertical menu (press ).

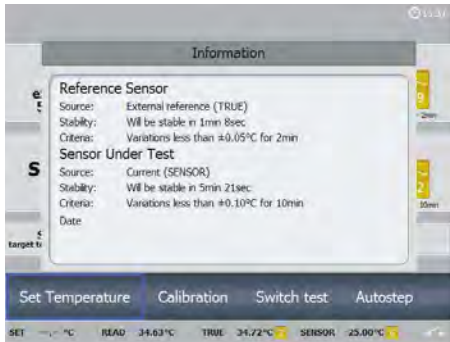

A status summary of the sensors setting and stability information is displayed.

If a warning or an error has occurred, it will be listed on the information screen.



Note...

The list will be cleared, when the calibrator is turned off.



Press  to exit the Info function.

4.13 About the calibrator



Information about the calibrator can be viewed using the About function from the vertical menu (press ) .



This informs you about the calibrator type, the software version installed, the serial number, the date when it was last calibrated, the build date and the build description.



Press  to exit the About function.

4.14 Simulation or training



Switch off the calibrator and switch it on again using the power control switch.

The start up screen is displayed.



Shortly after a black screen is displayed for a few seconds and then the start up screen is displayed again.



Now press and hold  down for a minimum of 5 seconds while the start screen is displayed.

The calibrator will start in the simulation mode.

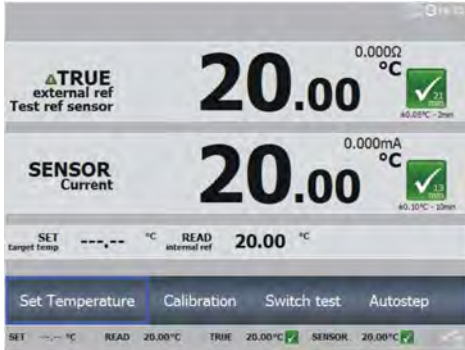

This mode is used to train personnel. The simulation differs from the standard setting in the following ways:

- The instrument does not actually heat up or cool down the well.
- The heating and cooling processes are simulated at exaggerated speeds.
- Data are not stored in the calibrator's memory.

The calibrator will remain in simulation mode until it is switched off.

5.0 After use

5.1 Storing and transporting the calibrator



Caution...

The following guidelines should always be observed when storing and transporting the calibrator. This will ensure that the instrument and the sensor remain in good working order (all versions).



Warning

The calibrator **must** be switched off before any attempt to service the instrument is made. There are no user serviceable parts inside the calibrator.

Switch off the calibrator using the power control switch. Note that the calibration procedure may be interrupted at any time using the power control switch. Turning off the calibrator during the calibration process will not damage either the instrument or the sensor.

The following routine must be observed **before the insertion tube is removed** and the instrument switched off:



Over 50°C/122°F

If the calibrator has been heated up to temperatures above 50°C/122°F, you must wait until the instrument reaches a temperature **below 50°C/122°F** before you switch it off.



Below 0°C/32°F

(applies only to the PTC-125/155 A/B/C models)

- **Do not** touch the well or insertion tube when these are below 0°C/32°F - they might create frostbite.
- If the calibrator has reached a temperature below 0°C/32°F, ice crystals may form on the insertion tube and on the well. This, in turn, may cause the material surfaces to oxidize.

To prevent this from happening, the insertion tube and the well must be dried. This is done by heating up the calibrator to min. 100°C/212°F until all water left has evaporated.

Remove the insulation plug while heating up.

It is very important that humidity in the well and insertion tube is removed to prevent corrosion and frost expansion damages.

Remove the insertion tube from the calibrator using the tool for insertion tube supplied with the instrument.

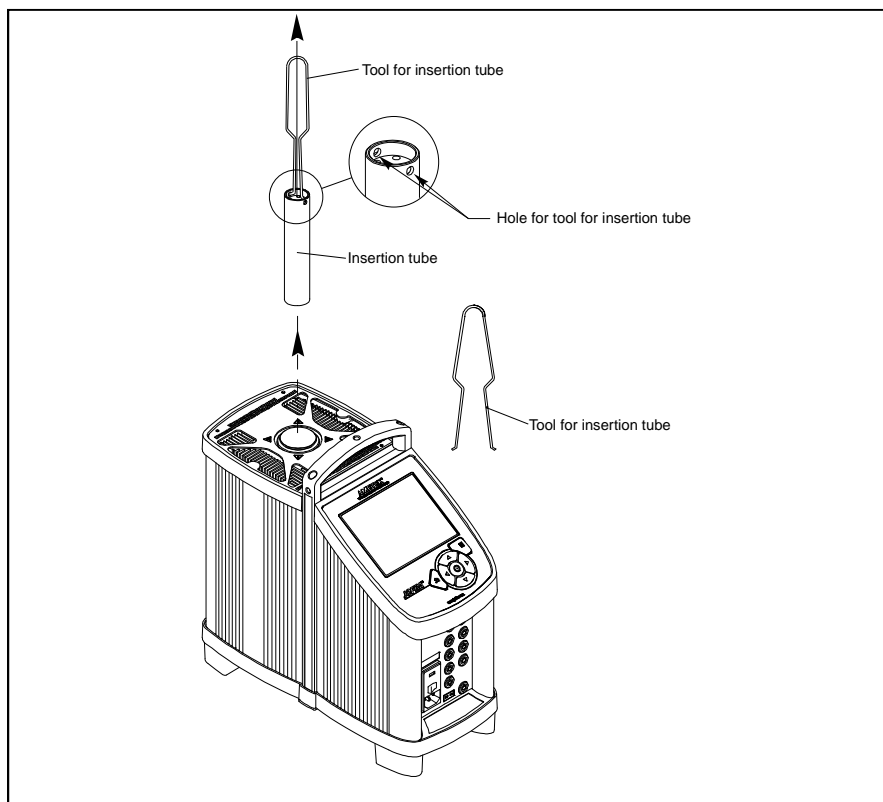

Fig. 11



Caution – Hot surface

Do not remove the insertion tube from the calibrator before the insertion tube has cooled down to less than 50°C/122°F



Caution...

- The insertion tube must **always** be removed from the calibrator after use.
The humidity in the air may cause corrosion oxidation on the insertion tube inside the instrument. There is a risk that the insertion tube may get stuck if this is allowed to happen.
- The insertion tube **must** be removed to avoid damage to the instrument if the calibrator is to be transported long distances.



Warning (all versions)

- **Never** leave hot insertion tubes that have been removed from the calibrator unsupervised – they may constitute a fire hazard or personal injury.

If you intend to store the calibrator in the optional aluminium carrying case after use, you **must** ensure that the instrument has cooled to a temperature **below 100°C/212°F** before placing it in the carrying case.

- **Never** place a hot insertion tube in the optional carrying case.
- **Do not** touch the well or insertion tube when these are deep frozen – they can create frostbite.

6.0 Replacing the main fuses



Warning

- The calibrator **must** be switched off before any attempt to service the instrument is made. There are no user serviceable parts inside the calibrator.
- The fuse box must not be removed from the power control switch until the mains cable has been disconnected.
- The two main fuses must have the specified current and voltage rating and be of the specified type. The use of makeshift fuses and the short-circuiting of fuse holders are prohibited and may cause a hazard.

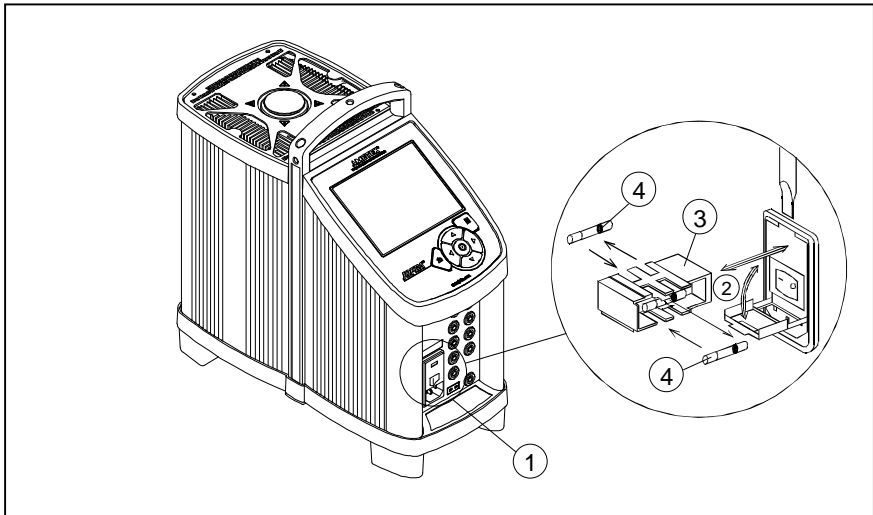

Fig. 12

- ① Locate the main fuses in the fuse box in the power control switch.
- ② Open the lid of the fuse box using a screwdriver.
- ③ Remove the fuse box.

④ Replace the fuses.

- PTC-125/155: 115V, 8AT = 127211 / 230V, 4AT = 127210
- PTC-350/425/660 115V, 10AF = 60B302 / 230V, 5AF = 127573

If the fuses blow immediately after you have replaced them, the calibrator should be returned to the manufacturer for service.

6.1 Error messages

Error messages are displayed in a dialog box with the following text:

Internal Error # xxx
Please read the manual for further information

Error #	Error text	Category	Solution
0	Read temperature lower than calibrator minimum temperature.	Warning	Please report the error to your local distributor or to AMETEK Denmark's service department.
1	Read temperature higher than calibrator maximum temperature.	Warning	Please report the error to your local distributor or to AMETEK Denmark's service department.
2	Read temperature higher than current SET-temperature.	Warning	Please report the error to your local distributor or to AMETEK Denmark's service department.
3	Zone 1 or zone 2 temperature deviation.	Warning	The calibrator could be stressed due to the insertion of too many sensors. Remove some of the sensors. If the error still occurs please report the error to your local distributor or to AMETEK Denmark's service department.
4	Internal reference measuring circuit error.	Warning	Please report the error to your local distributor or to AMETEK Denmark's service department.
5	Internal reference sensor error.	Warning	Please report the error to your local distributor or to AMETEK Denmark's service department.

Error #	Error text	Category	Solution
7	Zone 1 sensor error.	Warning	Please report the error to your local distributor or to AMETEK Denmark's service department.
8	Heater control error	Error	Please report the error to your local distributor or to AMETEK Denmark's service department.
9	Temperature protection	Error	Please report the error to your local distributor or to AMETEK Denmark's service department.
10	Temperature protection Stirling unit	Error	Please report the error to your local distributor or to AMETEK Denmark's service department.
11	Stirling unit error	Error	Please report the error to your local distributor or to AMETEK Denmark's service department.
12	Stirling unit Temperature too high	Error	Please report the error to your local distributor or to AMETEK Denmark's service department.
100	Sensor input board error	Error	Please report the error to your local distributor or to AMETEK Denmark's service department
101	The sensor input board has not been calibrated	Error	The sensor inputs (mA/Ω/mV) needs to be calibrated. Please report the error to your local distributor or to AMETEK Denmark's service department
102	Reference input board error	Error	Please report the error to your local distributor or to AMETEK Denmark's service department
103	The reference input board has not been calibrated	Error	The reference input needs to be calibrated. Please report the error to your local distributor or to AMETEK Denmark's service department
104	The calibration for the heat source has expired	Warning	Calibrate the heat source
105	The calibration for the sensor input board has expired	Warning	Calibrate the sensor input (mA/Ω/mV)

Error #	Error text	Category	Solution
106	The calibration for the reference input board has expired	Warning	Calibrate the reference input
107	The calibration for the external reference sensor has expired	Warning	Calibrate the external reference sensor
109	Heat source not calibrated	Error	The instrument needs to be calibrated

6.2 Returning the calibrator for service

When returning the calibrator to the manufacturer for service, please enclose a fully completed service information form. Simply copy the form on the following page and fill in the required information. The calibrator should be returned in the original packing.

The PTC-125 contains the flammable refrigerating gas R-1270 and the gas R-704. The amount of gas is less than 100g and it is considered not subject to the Dangerous Goods Regulations. However this must be declared when shipping.

When dispatching the PTC-125 please mark the package and the shipping papers with this text:

*** NOT RESTRICTED , SPECIAL PROVISION A103 ***



Note...

If the software detects an error during operation, the error will be shown in the display.

Make a note of the error message and contact your distributor or AMETEK Denmark's service department.

AMETEK Denmark's liability ceases if:

- parts are replaced/repared using spare parts which are not identical to those recommended by the manufacturer.
- non-original parts are used in any way when operating the instrument.

AMETEK Denmark's liability is restricted to errors that originated from the factory.

Service info

Customer data:**Date:**

Customer name and address: _____

Attention and Dept.: _____

Fax no./Phone no.: _____

Your order no.: _____

Delivery address: _____

Distributor name: _____

Instrument data:

Model and Serial no.: _____

Warranty claimed Yes: ___ No: ___ Original invoice no.: _____

Temp.
calibrationSensor
input**Service request:****This instrument is sent for
(please check off):**

___ Calibration as left

___ Check

___ Calibration as found and as left

___ Service

___ Accredited calibration as left

___ Repair

___ Accredited calibration as found and as left.

Diagnosis data/cause for return:

Diagnosis/Fault description: _____

Special requests: _____

Safety precautions: if the product has been exposed to any hazardous substances, it must be thoroughly decontaminated before it is returned to AMETEK. Details of the hazardous substances and any precautions to be taken must be enclosed.

7.0 Maintenance

7.1 Cleaning



Caution...

- Before cleaning the calibrator, you **must** switch it off, allow it to cool down and remove all cables.
- The insertion tube must **always** be removed from the calibrator after use.

The humidity in the air may cause corrosion oxidation on the insertion tube inside the instrument. There is a risk that the insertion tube may get stuck if this is allowed to happen.



Caution – Hot surface

Do not remove the insertion tube from the calibrator before the insertion tube has cooled down to less than 50°C/122°F



Warning (all versions)

- **Never** leave hot insertion tubes that have been removed from the calibrator unsupervised – they may constitute a fire hazard or personal injury.

If you intend to store the calibrator in the optional aluminium carrying case after use, you **must** ensure that the instrument has cooled to a temperature **below 100°C/212°F** before placing it in the carrying case.

- **Do not** touch the well or insertion tube when these are deep frozen – they can create frostbite.

Users should/must carry out the following cleaning procedures as and when required:

- The exterior of the instrument** – Clean using water or isopropyl alcohol and a soft cloth.
The cloth should be wrung out hard to avoid any water penetrating the calibrator and causing damage.
The keyboard may be cleaned using isopropyl alcohol when heavily soiled.
- If hazardous material is spilled onto or into the calibrator, the user is responsible for appropriate decontamination.
- Before using any decontamination or cleaning agents other than those specified in this manual, the user should check with AMETEK to ensure compatibility with the calibrator. Use of decontamination or cleaning agents incompatible with the calibrator may damage the calibrator or cause hazard.
- The insertion tube** – must **always** be clean and should be regularly wiped using a soft, lint-free, dry cloth.
You must ensure there are no textile fibres on the insertion tube when it is inserted in the well. The fibres may adhere to the well and damage it.
If the calibrator has reached a temperature below 0°C/32°F, ice crystals may form on the insertion tube. This, in turn, may cause the material surfaces to oxidize.
To prevent this from happening, the insertion tube must be dried. This is done by heating up the calibrator to min. 100°C/212°F until all water left has evaporated.
Remove the insulation plug while heating up.
It is very important that humidity in the insertion tube is removed to prevent corrosion and frost expansion damages.
- The well** – must **always** be clean.
Dust and textile fibres in the well should be removed from the dry-block calibrator using e.g. compressed air.



Warning

REMEMBER to wear goggles when using compressed air and cleaning oil.

If the calibrator has reached a temperature below 0°C/32°F, ice crystals may form on the well. This, in turn, may cause the material surfaces to oxidize.

To prevent this from happening, the well must be dried. This is done by heating up the calibrator to min. 100°C/212°F until all water left has evaporated.

Remove the insulation plug while heating up.

It is very important that humidity in the well is removed to prevent corrosion and frost expansion damages.

7.2 Adjusting and calibrating the instrument

You are advised to return the calibrator to AMETEK Denmark A/S or another accredited laboratory at least once a year for calibration.

Alternatively, you can calibrate/adjust the calibrator yourself using the AmeTrim Adjust and Calibration Software. See the separate Adjust and Calibration software manual – AmeTrim – 128160.

7.3 Maintenance of STS-reference sensor

Use the configuration software CON050 supplied with the PTC to update calibration information in the intelligent reference sensor.

Read the STS- and CON050 manuals for instruction about calibration and up-/download procedure.

The following information in the sensor is used by the PTC and must be filled in correctly:

- Serial number
- Model number
- Sensor type
- Temperature range Min/Max
- Electrical output Min/Max
- RTD type (CvD or ITS-90)
- Calibration date
- Calibration initials
- Calibration period
- R0, A, B and C (RTD type = CvD)
- RTPW, A(LR), B(LR)C(LR)/C1(LR), C2(LR), C3(LR), C4(LR), C5(LR) A(HR), B(HR), C(HR), D(HR) and W(HR) (RTD type = ITS-90)

All other data are not used by the PTC.

On the sensor calibration certificates, the coefficients can be listed using the ITS-90 names for coefficients. The table below can be used to convert the ITS-90 coefficient names to PTC-coefficient names for the ITS-90 subranges used in the PTC-calibrator temperature range.

ITS90 Subrange										
	3	4	5	6	7	8	9	10	11	
PTC coefficient	A(LR)	a3	a4	0						
	B(LR)	b3	b4	0						
	C(LR)/C1(LR)	c3	0	0						
	A(HR)			a5	a6	a7	a8	a9	a10	a11
	B(HR)			b5	b6	b7	b8	b9	0	0
	C(HR)			0	c6	c7	0	0	0	0
	D(HR)			0	d	0	0	0	0	0
W				w						

7.4 Testing the overtemperature function

It is recommended to test the overtemperature function every 12 months. The test is carried out as follows:

1. In the “Calibrator Setup” menu, set the “Max. SET temperature” to the maximum temperature of the calibrator.

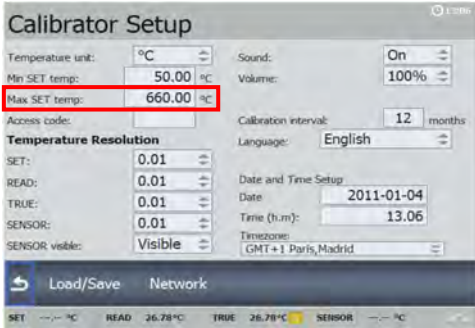

2. Press “Menu”  and set the SET temperature to the maximum value.
3. Let the calibrator heat to and stabilize at the maximum temperature.
4. Set the “Max. SET temperature” of the calibrator to 50°C below the maximum temperature of the calibrator.
If the Read temperature now starts decreasing, the overtemperature function is working properly.
5. Set the “Max. SET temperature” back to the maximum temperature of the calibrator and turn off/on the calibrator.
6. When powered up again, the calibrator will operate normally.

8.0 Technical specifications

The illustration below shows the setup that forms the basis for the technical specifications for dry-block calibrators.

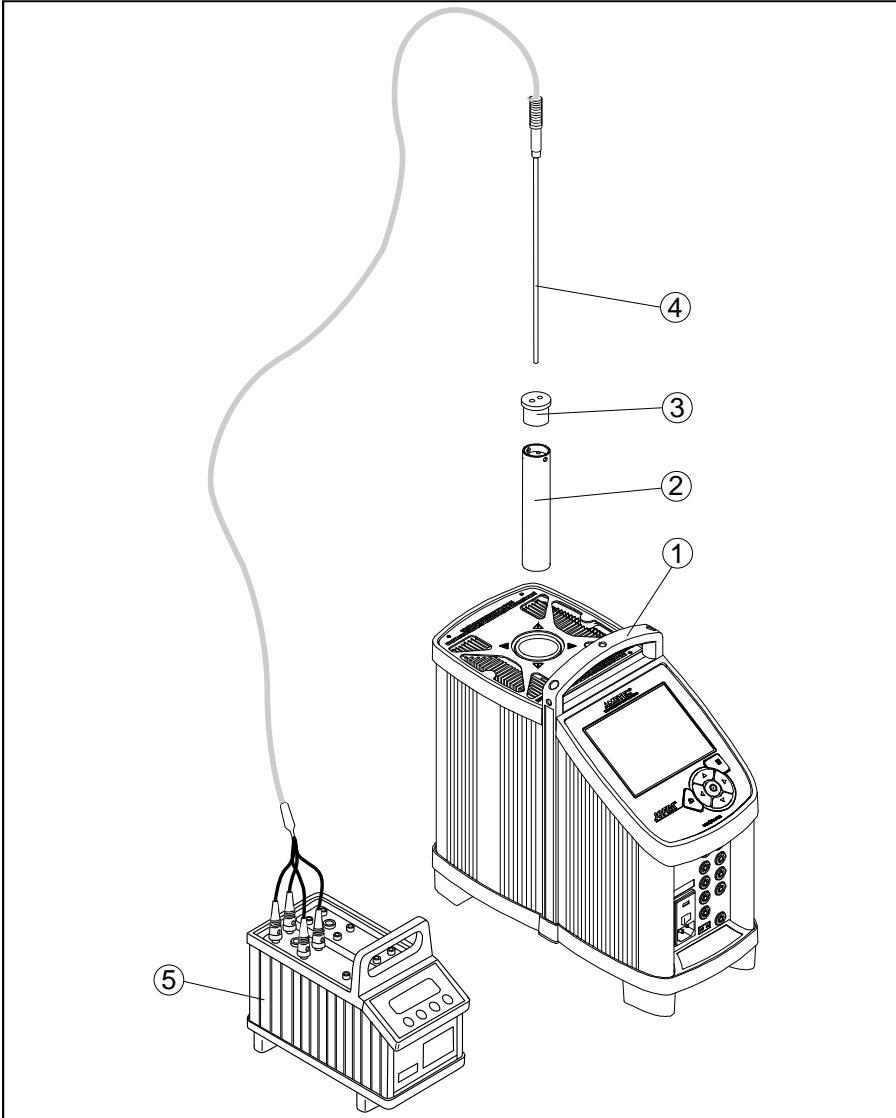

Fig. 13

Pos.	Description – dry-block calibrators
①	Calibrator
②	Insertion tube with Ø4.2 mm bore
③	Insulation plug (PTC-155 only)
④	Ø4 mm STS-150 sensor
⑤	DTI-1000 reference precision thermometer



Caution...

To get the best results out of your calibrator, the insertion tube dimensions, tolerance and material are critical. We highly advise using the JOFRA insertion tubes, as they guarantee trouble free operation. Use of other insertion tubes may reduce performance of the calibrator and cause the insertion tube to get stuck.

The illustration below shows the setup that forms the basis for the technical specifications for cooling calibrators.

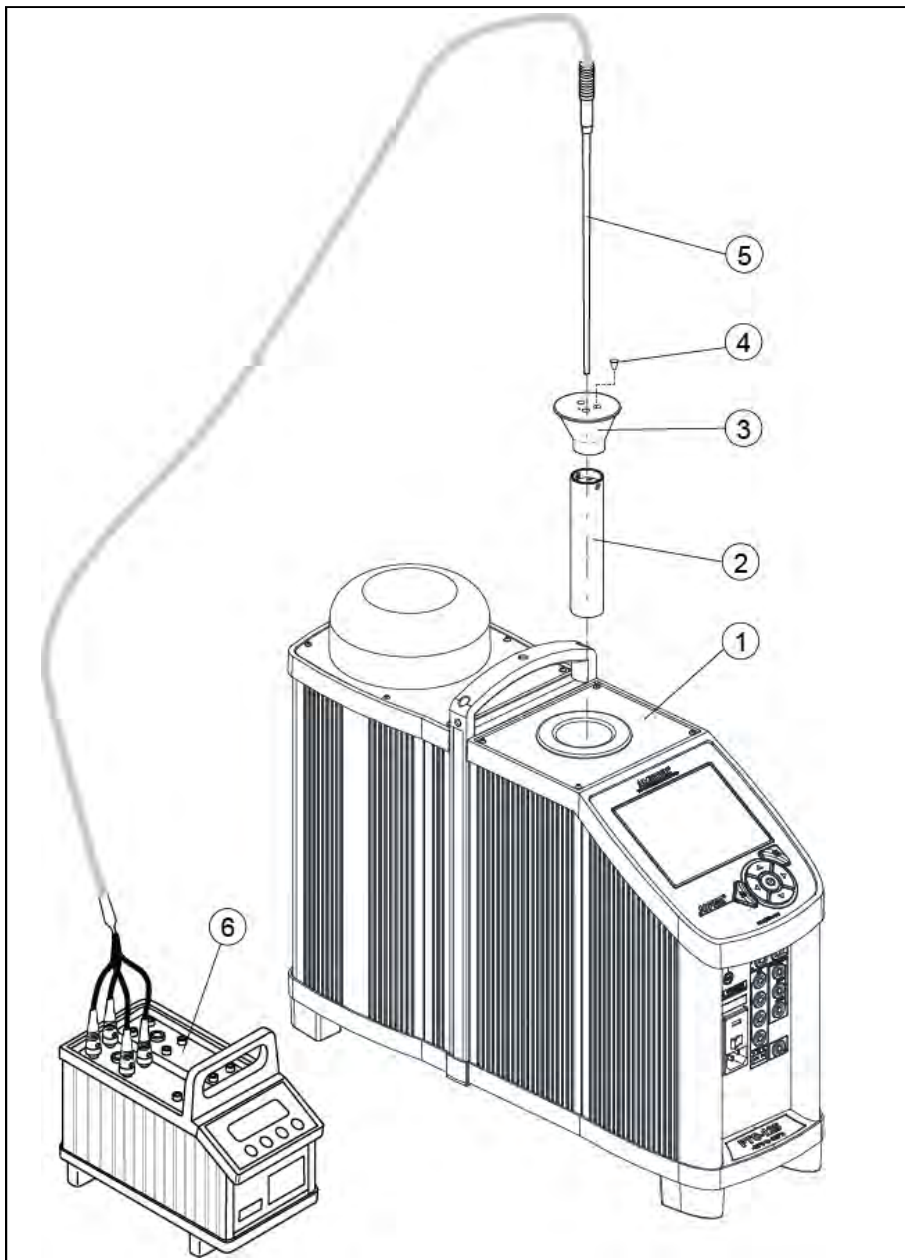

Fig. 14

Pos.	Description – cooling calibrators (fig. 14)
①	Calibrator
②	Insertion tube with Ø4.2mm bore
③	Insulation plug (PTC-125 only)
④	Silicone plug for insulation plug
⑤	Ø4 mm STS-200 sensor with traceable certificate
⑥	DTI-1000 reference precision thermometer with traceable certificate



Caution...

To get the best results out of your calibrator, the insertion tube dimensions, tolerance and material are critical. We highly advise using the JOFRA insertion tubes, as they guarantee trouble free operation. Use of other insertion tubes may reduce performance of the calibrator and cause the insertion tube to get stuck.

TECHNICAL SPECIFICATIONS

All specifications are given with an ambient temperature of 23°C/73.4°F ± 3°C/5.4°F

MECHANICAL SPECIFICATIONS

PTC-125 A/B/C

Dimensions l × w × h	531 × 171 × 432mm / 20.9 x 6.7 x 17 inch
Weight	PTC-125 A : 15.0 kg / 33.1 lb PTC-125 B : 15.2 kg / 33.5 lb PTC-125 C : 15.1 kg / 33.3 lb
Bore diameter/depth of well	ø30 mm / 185 mm – ø1.18 inch / 7.28 inch
Insert dimensions	ø29.7 mm x 150 mm / ø1.17 inch / 5.91 inch
Sensor immersion depth :	
from top of insert	140 mm / 5.51 inch
from top of insulation plug	190 mm / 7.48 inch
Weight non-drilled insert	290 g / 10.2 oz

POWER SUPPLY

Line voltage/frequency	90-127VAC / 180-254VAC 47-63 Hz
Power consumption	450 VA
Type of connection	IEC320

COMMUNICATION INTERFACES

Type of connections	USB A, USB B, RJ45
---------------------	--------------------

ENVIRONMENT

Ambient operating temperature range	0-40°C / 32-104°F
Storage temperature range	-20-50°C / -4-122°F
Humidity range	0-90% RH.
Protection class	IP10
Electromagnetic environment	Designed for use in basic and industrial electromagnetic environment as defined in EN61326-1 : 2013. Length of test cables should not exceed 3 m.

READOUT SPECIFICATIONS

Resolution	0.01°C / 0.01°F / 0.01 K
Temperature units	°C / °F / K

THERMAL SPECIFICATIONS	PTC-125 A/B/C
Maximum temperature	125°C / 257°F
Minimum temperature *	-90°C / -130°F @ ambient temperature 0°C / 32°F -90°C / -130°F @ ambient temperature 23°C / 73.4°F -73°C / -99.4°F @ ambient temperature 40°C / 104°F

* The minimum temperature will be affected by the number of sensors and the dimensions of the sensors being calibrated.

THERMAL SPECIFICATIONS

PTC-125 A/B/C

Well specifications

Loaded with 2 x 3mm + 1 x 6mm sensors:40 mm / 1.57 inch axial homogeneity:
 $\pm 0.070^{\circ}\text{C} / 0.126^{\circ}\text{F}$ @ $-90^{\circ}\text{C} / -130^{\circ}\text{F}$ to $23^{\circ}\text{C} / 73.4^{\circ}\text{F}$ 40 mm / 1.57 inch axial homogeneity:
 $\pm 0.050^{\circ}\text{C} / 0.09^{\circ}\text{F}$ @ $23^{\circ}\text{C} / 73.4^{\circ}\text{F}$ to $125^{\circ}\text{C} / 257^{\circ}\text{F}$ 50 mm / 1.97 inch axial homogeneity:
 $\pm 0.100^{\circ}\text{C} / 0.18^{\circ}\text{F}$ @ $-90^{\circ}\text{C} / -130^{\circ}\text{F}$ to $23^{\circ}\text{C} / 73.4^{\circ}\text{F}$ 50 mm / 1.97 inch axial homogeneity:
 $\pm 0.050^{\circ}\text{C} / 0.09^{\circ}\text{F}$ @ $23^{\circ}\text{C} / 73.4^{\circ}\text{F}$ to $125^{\circ}\text{C} / 257^{\circ}\text{F}$ 60 mm / 2.36 inch axial homogeneity:
 $\pm 0.150^{\circ}\text{C} / 0.27^{\circ}\text{F}$ @ $-90^{\circ}\text{C} / -130^{\circ}\text{F}$ to $23^{\circ}\text{C} / 73.4^{\circ}\text{F}$ 60 mm / 2.36 inch axial homogeneity:
 $\pm 0.050^{\circ}\text{C} / 0.09^{\circ}\text{F}$ @ $23^{\circ}\text{C} / 73.4^{\circ}\text{F}$ to $125^{\circ}\text{C} / 257^{\circ}\text{F}$ 70 mm / 2.76 inch axial homogeneity:
 $\pm 0.200^{\circ}\text{C} / 0.36^{\circ}\text{F}$ @ $-90^{\circ}\text{C} / -130^{\circ}\text{F}$ to $23^{\circ}\text{C} / 73.4^{\circ}\text{F}$ 70 mm / 2.76 inch axial homogeneity:
 $\pm 0.050^{\circ}\text{C} / 0.09^{\circ}\text{F}$ @ $23^{\circ}\text{C} / 73.4^{\circ}\text{F}$ to $125^{\circ}\text{C} / 257^{\circ}\text{F}$ 80 mm / 3.15 inch axial homogeneity:
 $\pm 0.400^{\circ}\text{C} / 0.72^{\circ}\text{F}$ @ $-90^{\circ}\text{C} / -130^{\circ}\text{F}$ to $23^{\circ}\text{C} / 73.4^{\circ}\text{F}$ 80 mm / 3.15 inch axial homogeneity:
 $\pm 0.050^{\circ}\text{C} / 0.09^{\circ}\text{F}$ @ $23^{\circ}\text{C} / 73.4^{\circ}\text{F}$ to $125^{\circ}\text{C} / 257^{\circ}\text{F}$

Difference between borings :

0.01°C/0.02°F

Influence from load :

0.25°C / 0.45°F @ -90°C / -130°F

0.10°C / 0.18°F @ 125°C / 257°F

Influence from load with Ext. Reference :

0.01°C/0.02°F

Long term drift (1 year) :

 $\pm 0.10^{\circ}\text{C} / \pm 0.18^{\circ}\text{F}$

Temperature coefficient

 $\pm 0.005^{\circ}\text{C} / ^{\circ}\text{C}$ (0-20°C and 26-40°C) / $\pm 0.009^{\circ}\text{F} / ^{\circ}\text{F}$
(32-68°F and 79-104°F)

Stability

 $\pm 0.030^{\circ}\text{C} / \pm 0.054^{\circ}\text{F}$

Accuracy

 $\pm 0.30^{\circ}\text{C} / \pm 0.54^{\circ}\text{F}$

Heating time incl. insert

 $-90^{\circ}\text{C} / -130^{\circ}\text{F}$ to $23^{\circ}\text{C} / 73.4^{\circ}\text{F}$: 15 min. $23^{\circ}\text{C} / 73.4^{\circ}\text{F}$ to $125^{\circ}\text{C} / 257^{\circ}\text{F}$: 13 min. $-90^{\circ}\text{C} / -130^{\circ}\text{F}$ to $125^{\circ}\text{C} / 257^{\circ}\text{F}$: 28 min.

Time to stability

10 min.

THERMAL SPECIFICATIONS**PTC-125 A/B/C**

Cooling time incl. insert	125°C / 257°F to 100°C / 212°F:	12 min.
	100°C / 212°F to 23°C / 73.4°F:	28 min.
	23°C / 73.4°F to -45°C / -49°F :	40 min.
	-45°C / -49°F to -80°C / -112°F	35 min.
	-80°C / -112°F to -90°C / -130°F:	30 min.
	125°C / 257°F to -90°C / -130°F :	145 min.
Refrigerants	R-704 (Helium) :	8 g / 0.3 oz
	R-1270 (Propylene) :	8 g / 0.3 oz

MECHANICAL SPECIFICATIONS	PTC-155 A/B/C
Dimensions l × w × h	362 × 171 × 363 mm / 14.2 x 6.7 x 14.3 inch
Weight	PTC-155 A/C: 10.2 kg / 22.5 lb PTC-155 B : 10.3 kg / 22.7 lb
Shipping dimensions	580 x 250 x 500mm / 22.8 x 9.8 x 19.7 inch (in cardboard box) 550 x 440 x 610mm / 21.7 x 17.3 x 24.0 inch (in trolley carrying case in cardboard box) 610 x 340 x 495mm / 24.0 x 13.4 x 19.5 inch (in carrying case in cardboard box)
Shipping weight	14.0 kg / 30.9 lb (in cardboard box) 19.0 kg / 41.9 lb (in carrying case in cardboard box) 23.9 kg / 52.7 lb (in trolley carrying case in cardboard box)
Bore diameter/depth of well	Ø26 mm / 150 mm – ø1.02 inch / 5.91 inch
Weight non-drilled insert	204 g / 7.2 oz
POWER SUPPLY	
Line voltage/frequency	90-127VAC / 180-254VAC 47-63 Hz
Power consumption	400 W
Type of connection	IEC320
COMMUNICATION INTERFACES	
Type of connections	USB A, USB B, RJ45
ENVIRONMENT	
Ambient operating temperature range	0-40°C / 32-104°F
Storage temperature range	-20-50°C / -4-122°F
Humidity range	0-90% RH.
Protection class	IP10
Electromagnetic environment	Designed for use in basic electromagnetic environment as defined in EN61326-1 : 2013. Length of test cables should not exceed 3 m.
READOUT SPECIFICATIONS	
Resolution	0.01°C / 0.01°F / 0.01 K
Temperature units	°C / °F / K

THERMAL SPECIFICATIONS**PTC-155 A/B/C**

Maximum temperature

155°C / 311°F

Minimum temperature *

-25°C / -13.0°F @ ambient temperature 0°C / 32°F

-25°C / -13.0°F @ ambient temperature 23°C / 73.4°F

-8°C / -17.6°F @ ambient temperature 40°C / 104°F

* The minimum temperature will be affected by the number of sensors and the dimensions of the sensors being calibrated.

Well specifications

Loaded with 2 x 3mm sensors:

40 mm / 1.57 inch axial homogeneity:
 $\pm 0.05^{\circ}\text{C}/0.09^{\circ}\text{F}$ @ $-25^{\circ}\text{C}/-13^{\circ}\text{F}$

40 mm / 1.57 inch axial homogeneity:
 $\pm 0.05^{\circ}\text{C}/0.09^{\circ}\text{F}$ @ $0^{\circ}\text{C}/32^{\circ}\text{F}$

40 mm / 1.57 inch axial homogeneity:
 $\pm 0.05^{\circ}\text{C}/0.09^{\circ}\text{F}$ @ $100^{\circ}\text{C}/212^{\circ}\text{F}$

40 mm / 1.57 inch axial homogeneity:
 $\pm 0.05^{\circ}\text{C}/0.09^{\circ}\text{F}$ @ $155^{\circ}\text{C}/311^{\circ}\text{F}$

50 mm / 1.97 inch axial homogeneity:
 $\pm 0.06^{\circ}\text{C}/0.108^{\circ}\text{F}$ @ $-25^{\circ}\text{C}/-13^{\circ}\text{F}$

50 mm / 1.97 inch axial homogeneity:
 $\pm 0.06^{\circ}\text{C}/0.108^{\circ}\text{F}$ @ $0^{\circ}\text{C}/32^{\circ}\text{F}$

50 mm / 1.97 inch axial homogeneity:
 $\pm 0.06^{\circ}\text{C}/0.108^{\circ}\text{F}$ @ $100^{\circ}\text{C}/212^{\circ}\text{F}$

50 mm / 1.97 inch axial homogeneity:
 $\pm 0.06^{\circ}\text{C}/0.108^{\circ}\text{F}$ @ $155^{\circ}\text{C}/311^{\circ}\text{F}$

60 mm / 2.36 inch axial homogeneity:
 $\pm 0.07^{\circ}\text{C}/0.126^{\circ}\text{F}$ @ $-25^{\circ}\text{C}/-13^{\circ}\text{F}$

60 mm / 2.36 inch axial homogeneity:
 $\pm 0.07^{\circ}\text{C}/0.126^{\circ}\text{F}$ @ $0^{\circ}\text{C}/32^{\circ}\text{F}$

60 mm / 2.36 inch axial homogeneity:
 $\pm 0.07^{\circ}\text{C}/0.126^{\circ}\text{F}$ @ $100^{\circ}\text{C}/212^{\circ}\text{F}$

60 mm / 2.36 inch axial homogeneity:
 $\pm 0.07^{\circ}\text{C}/0.126^{\circ}\text{F}$ @ $155^{\circ}\text{C}/311^{\circ}\text{F}$

70 mm / 2.76 inch axial homogeneity:
 $\pm 0.14^{\circ}\text{C}/0.252^{\circ}\text{F}$ @ $-25^{\circ}\text{C}/-13^{\circ}\text{F}$

70 mm / 2.76 inch axial homogeneity:
 $\pm 0.09^{\circ}\text{C}/0.162^{\circ}\text{F}$ @ $0^{\circ}\text{C}/32^{\circ}\text{F}$

70 mm / 2.76 inch axial homogeneity:
 $\pm 0.09^{\circ}\text{C}/0.162^{\circ}\text{F}$ @ $100^{\circ}\text{C}/212^{\circ}\text{F}$

70 mm / 2.76 inch axial homogeneity:
 $\pm 0.14^{\circ}\text{C}/0.252^{\circ}\text{F}$ @ $155^{\circ}\text{C}/311^{\circ}\text{F}$

80 mm / 3.15 inch axial homogeneity:
 $\pm 0.20^{\circ}\text{C}/0.36^{\circ}\text{F}$ @ $-25^{\circ}\text{C}/-13^{\circ}\text{F}$

80 mm / 3.15 inch axial homogeneity:
 $\pm 0.10^{\circ}\text{C}/0.18^{\circ}\text{F}$ @ $0^{\circ}\text{C}/32^{\circ}\text{F}$

80 mm / 3.15 inch axial homogeneity:
 $\pm 0.10^{\circ}\text{C}/0.18^{\circ}\text{F}$ @ $100^{\circ}\text{C}/212^{\circ}\text{F}$

80 mm / 3.15 inch axial homogeneity:
 $\pm 0.20^{\circ}\text{C}/0.36^{\circ}\text{F}$ @ $155^{\circ}\text{C}/311^{\circ}\text{F}$

THERMAL SPECIFICATIONS	PTC-155 A/B/C
	Difference between borings : 0.01°C/0.02°F
	Influence from load : 0.10°C/0.18°F
	Influence from load with Ext. Reference : 0.01°C/0.02°F
	Long term drift (1 year) : ±0.05°C/±0.09°F
Temperature coefficient	±0.007°C/°C (0-20°C and 26-40°C) / ±0.013°F/°F (32-68°F and 79-104°F)
Stability	±0.01°C/ ±0.018°F
Accuracy	±0.18°C/±0.32°F
Heating time incl. insert	-25°C / -13.0°F to 23°C / 73.4°F : 3 min. 23°C / 73.4°F to 155°C / 311°F : 12 min. -25°C / -13.0°F to 155°C / 311°F : 15 min.
Time to stability	10 min.
Cooling time incl. insert	155°C / 311°F to 23°C / 73.4°F: 10 min. 23°C / 73.4°F to -25°C / -13.0°F : 15 min. 155°C / 311°F to -25°C / -13.0°F : 25 min.
MECHANICAL SPECIFICATIONS	PTC-350 A/B/C
Dimensions l × w × h	362 × 171 × 363 mm / 14.2 x 6.7 x 14.3 inch
Weight	PTC-350 A/C : 8.1 kg / 17.9 lb PTC-350 B : 8.2 kg / 18.1 lb
Shipping dimensions	580 x 250 x 500mm / 22.8 x 9.8 x 19.7 inch (in cardboard box) 550 x 440 x 610mm / 21.7 x 17.3 x 24.0 inch (in trolley carrying case in cardboard box) 610 x 340 x 495mm / 24.0 x 13.4 x 19.5 inch (in carrying case in cardboard box)
Shipping weight	11.9 kg / 26.2 lb (in cardboard box) 16.9 kg / 37.2 lb (in carrying case in cardboard box) 21.8 kg / 48.1 lb (in trolley carrying case in cardboard box)
Bore diameter/depth of well	Ø26 mm / 150 mm – ø1.02 inch / 5.91 inch
Weight non-drilled insert	205 g / 7.2 oz

MECHANICAL SPECIFICATIONS**PTC-350 A/B/C**

POWER SUPPLY

Line voltage/frequency	90-127VAC / 180-254VAC 47-63 Hz
Power consumption	1150 W
Type of connection	IEC320

COMMUNICATION INTERFACES

Type of connections	USB A, USB B, RJ45
---------------------	--------------------

ENVIRONMENT

Ambient operating temperature range	0-40°C / 32-104°F
Storage temperature range	-20-50°C / -4-122°F
Humidity range	0-90% RH.
Protection class	IP10
Electromagnetic environment	Designed for use in basic electromagnetic environment as defined in EN61326-1 : 2013. Length of test cables should not exceed 3 m.

READOUT SPECIFICATIONS

Resolution	0.01°C / 0.01°F / 0.01 K
Temperature units	°C / °F / K

THERMAL SPECIFICATIONS**PTC-350 A/B/C**

Maximum temperature	350°C / 662°F
Minimum temperature *	10°C / 50°F @ ambient temperature 0°C / 32°F 33°C / 91.4°F @ ambient temperature 23°C / 73.4°F 50°C / 122°F @ ambient temperature 40°C / 104°F

Well specifications

Loaded with 2 x 3mm sensors:

40 mm / 1.57 inch axial homogeneity:
 $\pm 0.04^{\circ}\text{C} / 0.072^{\circ}\text{F}$ @ $33^{\circ}\text{C} / 91.4^{\circ}\text{F}$

40 mm / 1.57 inch axial homogeneity:
 $\pm 0.10^{\circ}\text{C} / 0.18^{\circ}\text{F}$ @ $200^{\circ}\text{C} / 392^{\circ}\text{F}$

40 mm / 1.57 inch axial homogeneity:
 $\pm 0.20^{\circ}\text{C} / 0.36^{\circ}\text{F}$ @ $350^{\circ}\text{C} / 662^{\circ}\text{F}$

50 mm / 1.97 inch axial homogeneity:
 $\pm 0.05^{\circ}\text{C} / 0.09^{\circ}\text{F}$ @ $33^{\circ}\text{C} / 91.4^{\circ}\text{F}$

50 mm / 1.97 inch axial homogeneity:
 $\pm 0.15^{\circ}\text{C} / 0.27^{\circ}\text{F}$ @ $200^{\circ}\text{C} / 392^{\circ}\text{F}$

50 mm / 1.97 inch axial homogeneity:
 $\pm 0.25^{\circ}\text{C} / 0.45^{\circ}\text{F}$ @ $350^{\circ}\text{C} / 662^{\circ}\text{F}$

60 mm / 2.36 inch axial homogeneity:
 $\pm 0.05^{\circ}\text{C} / 0.09^{\circ}\text{F}$ @ $33^{\circ}\text{C} / 91.4^{\circ}\text{F}$

60 mm / 2.36 inch axial homogeneity:
 $\pm 0.20^{\circ}\text{C} / 0.36^{\circ}\text{F}$ @ $200^{\circ}\text{C} / 392^{\circ}\text{F}$

60 mm / 2.36 inch axial homogeneity:
 $\pm 0.25^{\circ}\text{C} / 0.45^{\circ}\text{F}$ @ $350^{\circ}\text{C} / 662^{\circ}\text{F}$

70 mm / 2.76 inch axial homogeneity:
 $\pm 0.07^{\circ}\text{C} / 0.13^{\circ}\text{F}$ @ $33^{\circ}\text{C} / 91.4^{\circ}\text{F}$

70 mm / 2.76 inch axial homogeneity:
 $\pm 0.25^{\circ}\text{C} / 0.45^{\circ}\text{F}$ @ $200^{\circ}\text{C} / 392^{\circ}\text{F}$

70 mm / 2.76 inch axial homogeneity:
 $\pm 0.30^{\circ}\text{C} / 0.54^{\circ}\text{F}$ @ $350^{\circ}\text{C} / 622^{\circ}\text{F}$

80 mm / 3.15 inch axial homogeneity:
 $\pm 0.10^{\circ}\text{C} / 0.18^{\circ}\text{F}$ @ $33^{\circ}\text{C} / 91.4^{\circ}\text{F}$

80 mm / 3.15 inch axial homogeneity:
 $\pm 0.35^{\circ}\text{C} / 0.63^{\circ}\text{F}$ @ $200^{\circ}\text{C} / 392^{\circ}\text{F}$

80 mm / 3.15 inch axial homogeneity:
 $\pm 0.50^{\circ}\text{C} / 0.9^{\circ}\text{F}$ @ $350^{\circ}\text{C} / 622^{\circ}\text{F}$

Difference between borings $33^{\circ}\text{C} / 91.4^{\circ}\text{F}$:
 0.01°C (0.02°F)

Difference between borings $200^{\circ}\text{C} / 392^{\circ}\text{F}$:
 0.015°C (0.027°F)

Difference between borings $350^{\circ}\text{C} / 622^{\circ}\text{F}$:
 0.020°C (0.036°F)

Influence from load :
 0.15°C (0.27°F)

THERMAL SPECIFICATIONS**PTC-350 A/B/C**

	Influence from load with Ext. Reference :
	0.03°C / 0.054°F
	Long term drift (1 year) :
	±0.04°C / ±0.07°F
Calibration accuracy (test limit)	±0.06°C / ±0.108°F
Temperature coefficient	±0.010°C/°C (0-20°C and 26-40°C) / ±0.018°F/°F (32-68°F and 79-104°F)
Stability	±0.02°C / ±0.036°F
Accuracy	±0.20°C / ±0.36°F
Heating time incl. insert	33°C / 91.4°F to 350°C / 622°F : 7 min.
Time to stability	10 min.
Cooling time incl. Insert	350°C / 622°F to 100°C / 212°F: 12 min. 100°C / 212°F to 50°C / 122°F: 12 min. 50°C / 122°F to 33°C / 91.4°F : 13 min.

MECHANICAL SPECIFICATIONS**PTC-425 A/B/C**

Dimensions l × w × h	362 × 171 × 363 mm (14.3 x 6.7 x 14.3 inch)
Weight	PTC-425 A/C : 9.1 kg / 20.1 lb PTC-425 B : 9.2 kg / 20.3 lb
Shipping dimensions	580 x 250 x 500mm / 22.8 x 9.8 x 19.7 inch (in cardboard box) 550 x 440 x 610mm / 21.7 x 17.3 x 24.0 inch (in trolley carrying case in cardboard box) 610 x 340 x 495mm / 24.0 x 13.4 x 19.5 inch (in carrying case in cardboard box)
Shipping weight	12.9 kg / 28.4 lb (in cardboard box) 17.9 kg / 39.5 lb (in carrying case in cardboard box) 22.8 kg / 50.3 lb (in trolley carrying case in cardboard box)
Bore diameter/depth of well	Ø26 mm / 150 mm – ø1.024 inch / 5.91 inch
Weight non-drilled insert	280 g / 9.88 oz

MECHANICAL SPECIFICATIONS**PTC-425 A/B/C**

POWER SUPPLY

Line voltage/frequency	90-127VAC / 180-254VAC 45-65 Hz
Power consumption	1150 W
Type of connection	IEC320

COMMUNICATION INTERFACES

Type of connection	USB A, USB B, RJ45
--------------------	--------------------

ENVIRONMENT

Ambient operating temperature range	0-40°C / 32-104°F
Storage temperature range	-20-50°C / -4-122°F
Humidity range	0-90% RH.
Protection class	IP10
Electromagnetic environment	Designed for use in basic electromagnetic environment as defined in EN61326-1 : 2013. Length of test cables should not exceed 3 m.

READOUT SPECIFICATIONS

Resolution	0.01°C / 0.01°F / 0.01 K
Temperature units	°C / °F / K

THERMAL SPECIFICATIONS**PTC-425 A/B/C**

Maximum temperature	425°C / 797°F
Minimum temperature*	10°C / 50°F @ ambient temperature 0°C / 32°F 33°C / 91.4°F @ ambient temperature 23°C / 73.4°F 50°C / 122°F @ ambient temperature 40°C / 104°F

* The minimum temperature will be affected by the number of sensors and the dimensions of the sensors being calibrated.

Well specifications

Loaded with 2 x 3mm sensors:

40 mm / 1.57 inch axial homogeneity:
 $\pm 0.04^{\circ}\text{C}/0.072^{\circ}\text{F}$ @ $33^{\circ}\text{C}/91.4^{\circ}\text{F}$

40 mm / 1.57 inch axial homogeneity:
 $\pm 0.10^{\circ}\text{C}/0.18^{\circ}\text{F}$ @ $200^{\circ}\text{C}/392^{\circ}\text{F}$

40 mm / 1.57 inch axial homogeneity:
 $\pm 0.20^{\circ}\text{C}/0.36^{\circ}\text{F}$ @ $350^{\circ}\text{C}/662^{\circ}\text{F}$

40 mm / 1.57 inch axial homogeneity:
 $\pm 0.25^{\circ}\text{C}/0.45^{\circ}\text{F}$ @ $425^{\circ}\text{C}/797^{\circ}\text{F}$

50 mm / 1.97 inch axial homogeneity:
 $\pm 0.05^{\circ}\text{C}/0.09^{\circ}\text{F}$ @ $33^{\circ}\text{C}/91.4^{\circ}\text{F}$

50 mm / 1.97 inch axial homogeneity:
 $\pm 0.15^{\circ}\text{C}/0.27^{\circ}\text{F}$ @ $200^{\circ}\text{C}/392^{\circ}\text{F}$

50 mm / 1.97 inch axial homogeneity:
 $\pm 0.25^{\circ}\text{C}/0.45^{\circ}\text{F}$ @ $350^{\circ}\text{C}/662^{\circ}\text{F}$

50 mm / 1.97 inch axial homogeneity:
 $\pm 0.30^{\circ}\text{C}/0.54^{\circ}\text{F}$ @ $425^{\circ}\text{C}/797^{\circ}\text{F}$

60 mm / 2.36 inch axial homogeneity:
 $\pm 0.05^{\circ}\text{C}/0.09^{\circ}\text{F}$ @ $33^{\circ}\text{C}/91.4^{\circ}\text{F}$

60 mm / 2.36 inch axial homogeneity:
 $\pm 0.20^{\circ}\text{C}/0.36^{\circ}\text{F}$ @ $200^{\circ}\text{C}/392^{\circ}\text{F}$

60 mm / 2.36 inch axial homogeneity:
 $\pm 0.25^{\circ}\text{C}/0.45^{\circ}\text{F}$ @ $350^{\circ}\text{C}/662^{\circ}\text{F}$

60 mm / 2.36 inch axial homogeneity:
 $\pm 0.35^{\circ}\text{C}/0.65^{\circ}\text{F}$ @ $425^{\circ}\text{C}/797^{\circ}\text{F}$

70 mm / 2.76 inch axial homogeneity:
 $\pm 0.07^{\circ}\text{C}/0.13^{\circ}\text{F}$ @ $33^{\circ}\text{C}/91.4^{\circ}\text{F}$

70 mm / 2.76 inch axial homogeneity:
 $\pm 0.25^{\circ}\text{C}/0.45^{\circ}\text{F}$ @ $200^{\circ}\text{C}/392^{\circ}\text{F}$

70 mm / 2.76 inch axial homogeneity:
 $\pm 0.30^{\circ}\text{C}/0.54^{\circ}\text{F}$ @ $350^{\circ}\text{C}/662^{\circ}\text{F}$

70 mm / 2.76 inch axial homogeneity:
 $\pm 0.50^{\circ}\text{C}/0.90^{\circ}\text{F}$ @ $425^{\circ}\text{C}/797^{\circ}\text{F}$

80 mm / 3.15 inch axial homogeneity:
 $\pm 0.10^{\circ}\text{C}/0.18^{\circ}\text{F}$ @ $33^{\circ}\text{C}/91.4^{\circ}\text{F}$

80 mm / 3.15 inch axial homogeneity:
 $\pm 0.35^{\circ}\text{C}/0.63^{\circ}\text{F}$ @ $200^{\circ}\text{C}/392^{\circ}\text{F}$

80 mm / 3.15 inch axial homogeneity:
 $\pm 0.50^{\circ}\text{C}/0.9^{\circ}\text{F}$ @ $350^{\circ}\text{C}/662^{\circ}\text{F}$

80 mm / 3.15 inch axial homogeneity:
 $\pm 0.80^{\circ}\text{C}/1.44^{\circ}\text{F}$ @ $425^{\circ}\text{C}/797^{\circ}\text{F}$

THERMAL SPECIFICATIONS**PTC-425 A/B/C**

Well specifications – continue

Difference between borings 33°C/91.4°F :
0.01°C (0.02°F)Difference between borings 200°C/392°F :
0.015°C (0.027°F)Difference between borings 425°C/797°F:
0.020°C (0.036°F)Influence from load:
0.10°C (0.18°F)Influence from load with Ext. Reference :
0.03°C / 0.054°FLong term drift (1 year) :
±0.10°C / ±0.18°F

Calibration accuracy (test limit)

±0.06°C (±0.11°F)

Temperature coefficient

±0.020°C/°C (0-20°C and 26-40°C) / ±0.020°F/°F
(32-68°F and 79-104°F)

Stability

±0.02°C/0.036°F

Accuracy

±0.20°C/0.36°F @ 33°C/91.4°F to 350°C/662°F
±0.25°C/0.45°F @ 350°C/662°F to 425°C/797°F

Heating time incl. insert

33°C/91.4°F to 425°C/797°F : 10 min.

Time to stability

10 min.

Cooling time incl. insert

425°C / 797°F to 100°C / 212°F : 25 min.

100°C / 212°F to 50°C / 122°F : 16 min.

50°C / 122°F to 33°C / 91.4°F : 16 min.

MECHANICAL SPECIFICATIONS**PTC-660 A/B/C**

Dimensions l × w × h

362 × 171 × 363 mm (14.3 x 6.7 x 14.3 inch)

Weight

PTC-660 A/C : 8.8 kg / 19.4 lb

PTC-660 B : 8.9 kg / 19.6 lb

Shipping dimensions

580 x 250 x 500mm / 22.8 x 9.8 x 19.7 inch (in
cardboard box)550 x 440 x 610mm / 21.7 x 17.3 x 24.0 inch (in
trolley carrying case in cardboard box)

MECHANICAL SPECIFICATIONS	PTC-660 A/B/C
	610 x 340 x 495mm / 24.0 x 13.4 x 19.5 inch (in carrying case in cardboard box)
Shipping weight	12.6 kg / 27.8 lb (in cardboard box) 17.6 kg / 38.8 lb (in carrying case in cardboard box) 22.5 kg / 49.6 lb (in trolley carrying case in cardboard box)
Bore diameter/depth of well	Ø25 mm / 160 mm – ø0.98 inch / 6.3 inch
Weight non-drilled insert	630 g / 22.2 oz
Type of connection	IEC320
COMMUNICATION INTERFACES	
Type of connection	USB A, USB B, RJ45
ENVIRONMENT	
Ambient operating temperature range	0-40°C / 32-104°F
Storage temperature range	-20-50°C / -4-122°F
Humidity range	0-90% RH.
Protection class	IP10
Electromagnetic environment	Designed for use in basic electromagnetic environment as defined in EN61326-1 : 2013. Length of test cables should not exceed 3 m.
READOUT SPECIFICATIONS	
Resolution	0.01°C / 0.01°F / 0.01 K
Temperature units	°C / °F / K
THERMAL SPECIFICATIONS	PTC-660 A/B/C
Maximum temperature	660°C / 1220°F
Minimum temperature*	10°C / 50°F @ ambient temperature 0°C / 32°F 33°C / 91.4°F @ ambient temperature 23°C / 73.4°F 50°C / 122°F @ ambient temperature 40°C / 104°F

* The minimum temperature will be affected by the number of sensors and the dimensions of the sensors being calibrated.

Well specifications

Loaded with 4 x 4mm sensors:

40 mm / 1.57 inch axial homogeneity:
 $\pm 0.05^{\circ}\text{C}/0.09^{\circ}\text{F}$ @ $33^{\circ}\text{C}/91.4^{\circ}\text{F}$

40 mm / 1.57 inch axial homogeneity:
 $\pm 0.30^{\circ}\text{C}/0.54^{\circ}\text{F}$ @ $420^{\circ}\text{C}/788^{\circ}\text{F}$

40 mm / 1.57 inch axial homogeneity:
 $\pm 0.50^{\circ}\text{C}/0.9^{\circ}\text{F}$ @ $660^{\circ}\text{C}/1220^{\circ}\text{F}$

50 mm / 1.97 inch axial homogeneity:
 $\pm 0.05^{\circ}\text{C}/0.09^{\circ}\text{F}$ @ $33^{\circ}\text{C}/91.4^{\circ}\text{F}$

50 mm / 1.97 inch axial homogeneity:
 $\pm 0.45^{\circ}\text{C}/0.81^{\circ}\text{F}$ @ $420^{\circ}\text{C}/788^{\circ}\text{F}$

50 mm / 1.97 inch axial homogeneity:
 $\pm 0.60^{\circ}\text{C}/0.08^{\circ}\text{F}$ @ $660^{\circ}\text{C}/1220^{\circ}\text{F}$

60 mm / 2.36 inch axial homogeneity:
 $\pm 0.05^{\circ}\text{C}/0.09^{\circ}\text{F}$ @ $33^{\circ}\text{C}/91.4^{\circ}\text{F}$

60 mm / 2.36 inch axial homogeneity:
 $\pm 0.60^{\circ}\text{C}/0.08^{\circ}\text{F}$ @ $420^{\circ}\text{C}/788^{\circ}\text{F}$

60 mm / 2.36 inch axial homogeneity:
 $\pm 0.80^{\circ}\text{C}/0.44^{\circ}\text{F}$ @ $660^{\circ}\text{C}/1220^{\circ}\text{F}$

70 mm / 2.76 inch axial homogeneity:
 $\pm 0.10^{\circ}\text{C}/0.18^{\circ}\text{F}$ @ $33^{\circ}\text{C}/91.4^{\circ}\text{F}$

70 mm / 2.76 inch axial homogeneity:
 $\pm 0.75^{\circ}\text{C}/0.35^{\circ}\text{F}$ @ $420^{\circ}\text{C}/788^{\circ}\text{F}$

70 mm / 2.76 inch axial homogeneity:
 $\pm 1.10^{\circ}\text{C}/0.98^{\circ}\text{F}$ @ $660^{\circ}\text{C}/1220^{\circ}\text{F}$

80 mm / 3.15 inch axial homogeneity:
 $\pm 0.15^{\circ}\text{C}/0.27^{\circ}\text{F}$ @ $33^{\circ}\text{C}/91.4^{\circ}\text{F}$

80 mm / 3.15 inch axial homogeneity:
 $\pm 0.90^{\circ}\text{C}/0.62^{\circ}\text{F}$ @ $420^{\circ}\text{C}/788^{\circ}\text{F}$

80 mm / 3.15 inch axial homogeneity:
 $\pm 1.50^{\circ}\text{C}/1.70^{\circ}\text{F}$ @ $660^{\circ}\text{C}/1220^{\circ}\text{F}$

Difference between borings $33^{\circ}\text{C}/91.4^{\circ}\text{F}$:
 0.02°C (0.036°F)

Difference between borings $420^{\circ}\text{C}/788^{\circ}\text{F}$:
 0.05°C (0.09°F)

Difference between borings $660^{\circ}\text{C}/1220^{\circ}\text{F}$:
 0.10°C (0.18°F)

THERMAL SPECIFICATIONS

PTC-660 A/B/C

	Influence from load : 0.15°C (0.27°F) Influence from load with Ext. Reference : 0.05°C / 0.09°F Long term drift (1 year) : ±0.05°C / ±0.09°F
Calibration accuracy (test limit)	±0.20°C (±0.36°F)
Temperature coefficient	±0.020°C/°C (0-20°C and 26-40°C) / ±0.036°F/°F (32-68°F and 79-104°F)
Stability	±0.03°C/0.054°F @ 33°C/91.4°F to 420°C/788°F ±0.04°C/0.072°F @ 420°C/788°F to 660°C/1220°F
Accuracy	±0.30°C/0.54°F @ 33°C/91.4°F to 420°C/788°F ±0.50°C/0.9°F @ 420°C/788°F to 660°C/1220°F
Heating time incl. insert	33°C/91.4°F to 660°C/1220°F : 20 min.
Time to stability	10 min.
Cooling time incl. insert	660°C / 1220°F to 100°C / 212°F : 36 min. 100°C / 212°F to 50°C / 122°F : 15 min. 50°C / 122°F to 33°C / 91.4°F : 15 min.

STANDARDS

The following standards are observed according to the EMC-Directive (2014/30/EU)

EN 61326-1: 2013: Electrical equipment for measurement, control and laboratory use – EMC requirements

The following standards are observed according to the low voltage-directive (2014/35/EU)

EN61010-1:2010 : Safety requirements for electrical equipment for measurement, control and laboratory use, part 1: general requirement

EN61010-2-010:2014 : Safety requirements for electrical equipment for measurement, control and laboratory use, part 2-010: Particular requirements for laboratory equipment for the heating of materials (PTC-350/425/660 only)

EN61010-2-030:2010 : Safety requirements for electrical equipment for measurement, control and laboratory use, part 2-030: Particular requirements for testing and measuring circuits

PATENTS

PTC-125

Patented heating technology

Patent No.: EP2074374/US8342742

PTC-350/425/660

Patented fast cooling technology

Patent No.: EP2399107/US8721173

TECHNICAL SPECIFICATIONS – B VERSIONS ONLY

INPUT SPECIFICATIONS

mA input

Signal range	0 – 24 mA
Internal power supply	24 V, max. 28 mA
Resolution	0.001mA / 0.01°C / 0.01°F
Accuracy	±(0.02% of rdg. + 0.010% of F.S.)
Temperature coefficient	±11 ppm F.S./°C (0-20°C and 26-40°C) / (32-68°F and 79-104°F)
Input impedance	< 10 Ω
Type of connection	4 mm safety sockets

Thermocouple input

Signal range	-78mV – 78 mV (E, J, K, N, R, S, T, U, B)
Resolution	0.001mV / 0.01°C / 0.01°F (E, J, K, N, R, S, T, U, B)
Accuracy	±(0.02% of rdg. + 0.01% of F.S.), see page 119 – 121 for accuracy in °C/°F
Temperature coefficient	±7 ppm F.S./°C (0-20°C and 26-40°C) / (32-68°F and 79-104°F)
Input impedance	> 1 MΩ
Type of connection	Mini TC-connector

RTD-input (2-, 3- or 4-wire)

Signal range	0-400 Ω (*P10(90)385/*P50(90)385/P100(90)385/*P50(90)391/P100(90)391/P100(90)392/ *50(90)428/*M100(90)428/*H100(90)617/H120(90)672/*Pt-100 MILL)
* Optional	0-4000 Ω (*P200(90)385/*P500(90)385/P1000(90)385/*YSI-400)
Internal power supply	Excitation current 0.3 mA
Resolution	0.001Ω / 0.01°C / 0.01°F
* Optional	(*P10(90)385/*P50(90)385/P100(90)385/*P50(90)391/P100(90)391/P100(90)392/ *50(90)428/*M100(90)428/*H100(90)617/H120(90)672/*Pt-100 MILL)

INPUT SPECIFICATIONS

	0.01 Ω / 0.01 $^{\circ}$ C / 0.01 $^{\circ}$ F (*P200(90)385/*P500(90)385/P1000(90)385/ *YSI-400)
Accuracy	$\pm(0.006\%$ of rdg. + 0.002% of F.S.), (0-400 Ω range), see page 122 - 125 for accuracy in $^{\circ}$ C/ $^{\circ}$ F $\pm(0.006\%$ of rdg. + 0.005% of F.S.), (0-4000 Ω range), see page 121 - 122 + 126 for accuracy in $^{\circ}$ C/ $^{\circ}$ F
Temperature coefficient	± 5 ppm F.S./ $^{\circ}$ C (0-20 $^{\circ}$ C and 26-40 $^{\circ}$ C) / (32- 68 $^{\circ}$ F and 79-104 $^{\circ}$ F)
Type of connection	4 mm safety sockets
Switch test input	
Signal range	on : 0-10k Ω / off : >100k Ω
Internal power supply	5 V (open)
Type of connection	4 mm safety sockets
Reference input (4 wire true ohm Pt100) B and C versions only	
Signal range	0 Ω – 400 Ω
Internal power supply	Measuring current 0.8 mA
Resolution	0.001 Ω / 0.01 $^{\circ}$ C / 0.01 $^{\circ}$ F
Accuracy	$\pm(0.003\%$ of rdg. + 0.0007% of F.S.), see page 126 for accuracy in $^{\circ}$ C/ $^{\circ}$ F
Temperature coefficient	± 5 ppm F.S./ $^{\circ}$ C (0-20 $^{\circ}$ C and 26-40 $^{\circ}$ C) / (32- 68 $^{\circ}$ F and 79-104 $^{\circ}$ F)
Type of connection	LEMO Redell 6-pole-connector

INPUT SPECIFICATIONS**ACCURACY IN °C/°F**

Accuracy thermocouple type E input
-200°C to 1000°C
(excluding sensor accuracy)

±0.39°C(±0.70°F) @ -200°C(-328°F)
±0.20°C(±0.35°F) @ -100°C(-148°F)
±0.14°C(±0.25°F) @ 0°C(32°F)
±0.14°C(±0.25°F) @ 155°C(311°F)
±0.17°C(±0.31°F) @ 350°C(662°F)
±0.22°C(±0.40°F) @ 660°C(1220°F)
±0.31°C(±0.55°F) @ 1000°C(1832°F)

Accuracy thermocouple type J input
-210°C to 1200°C
(excluding sensor accuracy)

±0.50°C(±0.89°F) @ -210°C(-346°F)
±0.22°C(±0.39°F) @ -100°C(-148°F)
±0.17°C(±0.31°F) @ 0°C(32°F)
±0.17°C(±0.31°F) @ 155°C(311°F)
±0.23°C(±0.41°F) @ 350°C(662°F)
±0.25°C(±0.45°F) @ 660°C(1220°F)
±0.38°C(±0.69°F) @ 1200°C(2192°F)

Accuracy thermocouple type K input
-200°C to 1372°C
(excluding sensor accuracy)

±0.58°C(±1.04°F) @ -200°C(-328°F)
±0.28°C(±0.51°F) @ -100°C(-148°F)
±0.22°C(±0.40°F) @ 0°C(32°F)
±0.22°C(±0.40°F) @ 155°C(311°F)
±0.26°C(±0.48°F) @ 350°C(662°F)
±0.32°C(±0.57°F) @ 660°C(1220°F)
±0.56°C(±1.01°F) @ 1372°C(2502°F)

Accuracy thermocouple type T input
-200°C to 400°C
(excluding sensor accuracy)

±0.58°C(±1.04°F) @ -200°C(-328°F)
±0.30°C(±0.54°F) @ -100°C(-148°F)
±0.20°C(±0.36°F) @ 0°C(32°F)
±0.20°C(±0.36°F) @ 155°C(311°F)
±0.19°C(±0.35°F) @ 350°C(662°F)
±0.19°C(±0.35°F) @ 400°C(752°F)

INPUT SPECIFICATIONS**ACCURACY IN °C/°F**

Accuracy thermocouple type R input

-50°C to 1768°C

(excluding sensor accuracy)

±2.62°C(±4.71°F) @ -50°C(-58°F)

±1.56°C(±2.81°F) @ 0°C(32°F)

±1.56°C(±2.81°F) @ 155°C(311°F)

±0.83°C(±1.50°F) @ 350°C(662°F)

±0.75°C(±1.36°F) @ 660°C(1220°F)

±1.00°C(±1.80°F) @ 1768°C(3214°F)

Accuracy thermocouple type S input

-50°C to 1768°C

(excluding sensor accuracy)

±1.96°C(±3.53°F) @ -50°C(-58°F)

±1.56°C(±2.81°F) @ 0°C(32°F)

±1.56°C(±2.81°F) @ 155°C(311°F)

±0.92°C(±1.66°F) @ 350°C(662°F)

±0.85°C(±1.53°F) @ 660°C(1220°F)

±1.10°C(±1.98°F) @ 1768°C(3214°F)

Accuracy thermocouple type B

250°C to 1820°C

(excluding sensor accuracy)

±3.17°C(±5.70°F) @ 250°C(482°F)

±2.42°C(±4.35°F) @ 350°C(662°F)

±1.32°C(±2.37°F) @ 660°C(1220°F)

±0.93°C(±1.67°F) @ 1820°C(3308°F)

Accuracy thermocouple type N

-200°C to 1300°C

(excluding sensor accuracy)

±0.86°C(±1.55°F) @ -200°C(-328°F)

±0.40°C(±0.73°F) @ -100°C(-148°F)

±0.30°C(±0.54°F) @ 0°C(32°F)

±0.30°C(±0.54°F) @ 155°C(311°F)

±0.29°C(±0.52°F) @ 350°C(662°F)

±0.32°C(±0.57°F) @ 660°C(1220°F)

±0.35°C(±0.62°F) @ 800°C(1472°F)

±0.39°C(±0.70°F) @ 1000°C(1832°F)

±0.44°C(±0.80°F) @ 1200°C(2192°F)

±0.48°C(±0.87°F) @ 1300°C(2372°F)

INPUT SPECIFICATIONS

ACCURACY IN °C/°F

Accuracy thermocouple type L

-200°C to 900°C

(excluding sensor accuracy)

±0.30°C(±0.55°F) @ -200°C(-328°F)

±0.20°C(±0.35°F) @ -100°C(-148°F)

±0.15°C(±0.27°F) @ 0°C(32°F)

±0.15°C(±0.27°F) @ 155°C(311°F)

±0.22°C(±0.39°F) @ 350°C(662°F)

±0.25°C(±0.45°F) @ 660°C(1220°F)

±0.26°C(±0.47°F) @ 900°C(1652°F)

Accuracy thermocouple type U

-80°C to 600°C

(excluding sensor accuracy)

±0.27°C(±0.49°F) @ -80°C(-112°F)

±0.20°C(±0.36°F) @ 0°C(32°F)

±0.18°C(±0.33°F) @ 155°C(311°F)

±0.19°C(±0.35°F) @ 350°C(662°F)

±0.21°C(±0.37°F) @ 600°C(1112°F)

Accuracy automatic cold junction
compensation±0.35°C(±0.63°F) @ ambient temperature 0°C
to 40°C.

Accuracy RTD Pt1000 385

Pt1000(90)385: -200°C to 850°C

* Pt1000(68)385: -200°C to 850°C

(excluding sensor accuracy)

±0.05°C(±0.09°F) @ -200°C(-328°F)

±0.06°C(±0.11°F) @ -90°C(-130°F)

±0.07°C(±0.12°F) @ -50°C(-58°F)

±0.07°C(±0.12°F) @ 0°C(32°F)

±0.08°C(±0.15°F) @ 155°C(311°F)

±0.10°C(±0.18°F) @ 350°C(662°F)

±0.11°C(±0.19°F) @ 420°C(788°F)

±0.13°C(±0.23°F) @ 660°C(1220°F)

±0.14°C(±0.24°F) @ 700°C(1292°F)

±0.15°C(±0.27°F) @ 850°C(1562°F)

Accuracy RTD

* Pt500(90)385: -200°C to 850°C

(excluding sensor accuracy)

±0.10°C(±0.18°F) @ -200°C(-328°F)

±0.11°C(±0.20°F) @ -90°C(-130°F)

±0.12°C(±0.21°F) @ -50°C(-58°F)

±0.12°C(±0.22°F) @ 0°C(32°F)

±0.14°C(±0.24°F) @ 155°C(311°F)

±0.16°C(±0.28°F) @ 350°C(662°F)

±0.17°C(±0.30°F) @ 420°C(788°F)

±0.20°C(±0.35°F) @ 660°C(1220°F)

±0.22°C(±0.40°F) @ 850°C(1562°F)

INPUT SPECIFICATIONS**ACCURACY IN °C/°F**

Accuracy RTD

* Pt400(90)385: -200°C to 850°C
(excluding sensor accuracy) $\pm 0.12^{\circ}\text{C}(\pm 0.22^{\circ}\text{F})$ @ -200°C(-328°F)
 $\pm 0.14^{\circ}\text{C}(\pm 0.25^{\circ}\text{F})$ @ -90°C(-130°F)
 $\pm 0.14^{\circ}\text{C}(\pm 0.25^{\circ}\text{F})$ @ -50°C(-58°F)
 $\pm 0.15^{\circ}\text{C}(\pm 0.26^{\circ}\text{F})$ @ 0°C(32°F)
 $\pm 0.16^{\circ}\text{C}(\pm 0.28^{\circ}\text{F})$ @ 155°C(311°F)
 $\pm 0.19^{\circ}\text{C}(\pm 0.33^{\circ}\text{F})$ @ 350°C(662°F)
 $\pm 0.20^{\circ}\text{C}(\pm 0.35^{\circ}\text{F})$ @ 420°C(788°F)
 $\pm 0.23^{\circ}\text{C}(\pm 0.41^{\circ}\text{F})$ @ 660°C(1220°F)
 $\pm 0.26^{\circ}\text{C}(\pm 0.46^{\circ}\text{F})$ @ 850°C(1562°F)

Accuracy RTD

* Pt200(90)385: -200°C to 850°C
(excluding sensor accuracy) $\pm 0.24^{\circ}\text{C}(\pm 0.43^{\circ}\text{F})$ @ -200°C(-328°F)
 $\pm 0.26^{\circ}\text{C}(\pm 0.47^{\circ}\text{F})$ @ -90°C(-130°F)
 $\pm 0.27^{\circ}\text{C}(\pm 0.48^{\circ}\text{F})$ @ -50°C(-58°F)
 $\pm 0.28^{\circ}\text{C}(\pm 0.49^{\circ}\text{F})$ @ 0°C(32°F)
 $\pm 0.30^{\circ}\text{C}(\pm 0.53^{\circ}\text{F})$ @ 155°C(311°F)
 $\pm 0.33^{\circ}\text{C}(\pm 0.59^{\circ}\text{F})$ @ 350°C(662°F)
 $\pm 0.34^{\circ}\text{C}(\pm 0.61^{\circ}\text{F})$ @ 420°C(788°F)
 $\pm 0.39^{\circ}\text{C}(\pm 0.69^{\circ}\text{F})$ @ 660°C(1220°F)
 $\pm 0.43^{\circ}\text{C}(\pm 0.76^{\circ}\text{F})$ @ 850°C(1562°F)

Accuracy RTD

Pt100(90)385: -200°C to 850°C
* Pt100(68)385: -200°C to 850°C
(excluding sensor accuracy) $\pm 0.03^{\circ}\text{C}(\pm 0.04^{\circ}\text{F})$ @ -200°C(-328°F)
 $\pm 0.03^{\circ}\text{C}(\pm 0.06^{\circ}\text{F})$ @ -90°C(-130°F)
 $\pm 0.04^{\circ}\text{C}(\pm 0.06^{\circ}\text{F})$ @ -50°C(-58°F)
 $\pm 0.04^{\circ}\text{C}(\pm 0.06^{\circ}\text{F})$ @ 0°C(32°F)
 $\pm 0.05^{\circ}\text{C}(\pm 0.08^{\circ}\text{F})$ @ 155°C(311°F)
 $\pm 0.06^{\circ}\text{C}(\pm 0.11^{\circ}\text{F})$ @ 350°C(662°F)
 $\pm 0.07^{\circ}\text{C}(\pm 0.11^{\circ}\text{F})$ @ 420°C(788°F)
 $\pm 0.08^{\circ}\text{C}(\pm 0.15^{\circ}\text{F})$ @ 660°C(1220°F)
 $\pm 0.10^{\circ}\text{C}(\pm 0.17^{\circ}\text{F})$ @ 850°C(1562°F)

INPUT SPECIFICATIONS**ACCURACY IN °C/°F**

Accuracy RTD

*Pt50(90)385: -200°C to 850°C

* Pt50(68)385: -200°C to 850°C

(excluding sensor accuracy)

±0.04°C(±0.08°F) @ -200°C(-328°F)

±0.05°C(±0.09°F) @ -90°C(-130°F)

±0.06°C(±0.10°F) @ -50°C(-58°F)

±0.06°C(±0.10°F) @ 0°C(32°F)

±0.07°C(±0.12°F) @ 155°C(311°F)

±0.08°C(±0.15°F) @ 320°C(608°F)

±0.09°C(±0.16°F) @ 420°C(788°F)

±0.11°C(±0.19°F) @ 660°C(1220°F)

±0.13°C(±0.22°F) @ 850°C(1562°F)

Accuracy RTD

*Pt10(90)385: -200°C to 850°C

(excluding sensor accuracy)

±0.19°C(±0.34°F) @ -200°C(-328°F)

±0.21°C(±0.38°F) @ -90°C(-130°F)

±0.22°C(±0.39°F) @ -50°C(-58°F)

±0.22°C(±0.40°F) @ 0°C(32°F)

±0.24°C(±0.43°F) @ 155°C(311°F)

±0.27°C(±0.48°F) @ 350°C(662°F)

±0.28°C(±0.49°F) @ 420°C(788°F)

±0.31°C(±0.56°F) @ 660°C(1220°F)

±0.35°C(±0.62°F) @ 850°C(1562°F)

Accuracy RTD

Pt100(90)391: -200°C to 850°C

* Pt100(68)391: -200°C to 850°C

*Pt100(06)391: -200°C to 850°C

(excluding sensor accuracy)

±0.02°C(±0.04°F) @ -200°C(-328°F)

±0.03°C(±0.05°F) @ -90°C(-130°F)

±0.03°C(±0.06°F) @ -50°C(-58°F)

±0.04°C(±0.06°F) @ 0°C(32°F)

±0.05°C(±0.08°F) @ 155°C(311°F)

±0.06°C(±0.11°F) @ 350°C(668°F)

±0.06°C(±0.11°F) @ 420°C(788°F)

±0.08°C(±0.14°F) @ 660°C(1220°F)

±0.10°C(±0.17°F) @ 850°C(1562°F)

INPUT SPECIFICATIONS**ACCURACY IN °C/°F**

Accuracy RTD	$\pm 0.04^{\circ}\text{C}(\pm 0.07^{\circ}\text{F}) @ -200^{\circ}\text{C}(-328^{\circ}\text{F})$
*Pt50(90)391: -200°C to 1100°C	$\pm 0.05^{\circ}\text{C}(\pm 0.09^{\circ}\text{F}) @ -90^{\circ}\text{C}(-130^{\circ}\text{F})$
* Pt50(68)391: -200°C to 1100°C	$\pm 0.05^{\circ}\text{C}(\pm 0.09^{\circ}\text{F}) @ -50^{\circ}\text{C}(-58^{\circ}\text{F})$
*Pt50(06)391: -200°C to 850°C	$\pm 0.06^{\circ}\text{C}(\pm 0.10^{\circ}\text{F}) @ 0^{\circ}\text{C}(32^{\circ}\text{F})$
(excluding sensor accuracy)	$\pm 0.07^{\circ}\text{C}(\pm 0.12^{\circ}\text{F}) @ 155^{\circ}\text{C}(311^{\circ}\text{F})$
	$\pm 0.08^{\circ}\text{C}(\pm 0.14^{\circ}\text{F}) @ 350^{\circ}\text{C}(662^{\circ}\text{F})$
	$\pm 0.09^{\circ}\text{C}(\pm 0.15^{\circ}\text{F}) @ 420^{\circ}\text{C}(788^{\circ}\text{F})$
	$\pm 0.11^{\circ}\text{C}(\pm 0.19^{\circ}\text{F}) @ 660^{\circ}\text{C}(1220^{\circ}\text{F})$
	$\pm 0.12^{\circ}\text{C}(\pm 0.22^{\circ}\text{F}) @ 850^{\circ}\text{C}(1562^{\circ}\text{F})$
	$\pm 0.15^{\circ}\text{C}(\pm 0.27^{\circ}\text{F}) @ 1100^{\circ}\text{C}(2012^{\circ}\text{F})$
Accuracy RTD	$\pm 0.03^{\circ}\text{C}(\pm 0.04^{\circ}\text{F}) @ -200^{\circ}\text{C}(-328^{\circ}\text{F})$
Pt100(90)392: -200°C to 630°C	$\pm 0.03^{\circ}\text{C}(\pm 0.05^{\circ}\text{F}) @ -90^{\circ}\text{C}(-130^{\circ}\text{F})$
(excluding sensor accuracy)	$\pm 0.03^{\circ}\text{C}(\pm 0.06^{\circ}\text{F}) @ -50^{\circ}\text{C}(-58^{\circ}\text{F})$
	$\pm 0.04^{\circ}\text{C}(\pm 0.06^{\circ}\text{F}) @ 0^{\circ}\text{C}(32^{\circ}\text{F})$
	$\pm 0.05^{\circ}\text{C}(\pm 0.08^{\circ}\text{F}) @ 155^{\circ}\text{C}(311^{\circ}\text{F})$
	$\pm 0.06^{\circ}\text{C}(\pm 0.10^{\circ}\text{F}) @ 320^{\circ}\text{C}(608^{\circ}\text{F})$
	$\pm 0.06^{\circ}\text{C}(\pm 0.11^{\circ}\text{F}) @ 420^{\circ}\text{C}(788^{\circ}\text{F})$
	$\pm 0.08^{\circ}\text{C}(\pm 0.14^{\circ}\text{F}) @ 630^{\circ}\text{C}(1166^{\circ}\text{F})$
Accuracy RTD	$\pm 0.03^{\circ}\text{C}(\pm 0.04^{\circ}\text{F}) @ -200^{\circ}\text{C}(-328^{\circ}\text{F})$
* M100(90)428: -200°C to 200°C	$\pm 0.03^{\circ}\text{C}(\pm 0.05^{\circ}\text{F}) @ -90^{\circ}\text{C}(-130^{\circ}\text{F})$
* M100(68)428: -200°C to 200°C	$\pm 0.03^{\circ}\text{C}(\pm 0.05^{\circ}\text{F}) @ -50^{\circ}\text{C}(-58^{\circ}\text{F})$
* M100(06)428: -180°C to 200°C	$\pm 0.04^{\circ}\text{C}(\pm 0.06^{\circ}\text{F}) @ 0^{\circ}\text{C}(32^{\circ}\text{F})$
(excluding sensor accuracy)	$\pm 0.04^{\circ}\text{C}(\pm 0.07^{\circ}\text{F}) @ 155^{\circ}\text{C}(311^{\circ}\text{F})$
	$\pm 0.05^{\circ}\text{C}(\pm 0.08^{\circ}\text{F}) @ 200^{\circ}\text{C}(392^{\circ}\text{F})$
Accuracy RTD	$\pm 0.04^{\circ}\text{C}(\pm 0.07^{\circ}\text{F}) @ -200^{\circ}\text{C}(-328^{\circ}\text{F})$
* M50(90)428 : -200°C to 200°C	$\pm 0.05^{\circ}\text{C}(\pm 0.08^{\circ}\text{F}) @ -90^{\circ}\text{C}(-130^{\circ}\text{F})$
* M50(68)428 : -200°C to 200°C	$\pm 0.05^{\circ}\text{C}(\pm 0.09^{\circ}\text{F}) @ -50^{\circ}\text{C}(-58^{\circ}\text{F})$
* M50(06)428 : -180°C to 200°C	$\pm 0.05^{\circ}\text{C}(\pm 0.09^{\circ}\text{F}) @ 0^{\circ}\text{C}(32^{\circ}\text{F})$
(excluding sensor accuracy)	$\pm 0.06^{\circ}\text{C}(\pm 0.11^{\circ}\text{F}) @ 155^{\circ}\text{C}(311^{\circ}\text{F})$
	$\pm 0.06^{\circ}\text{C}(\pm 0.11^{\circ}\text{F}) @ 200^{\circ}\text{C}(392^{\circ}\text{F})$

INPUT SPECIFICATIONS**ACCURACY IN °C/°F**

Accuracy RTD

 $\pm 0.03^{\circ}\text{C}(\pm 0.06^{\circ}\text{F}) @ -50^{\circ}\text{C}(-58^{\circ}\text{F})$ * M100(90)426: -50°C to 200°C $\pm 0.04^{\circ}\text{C}(\pm 0.06^{\circ}\text{F}) @ 0^{\circ}\text{C}(32^{\circ}\text{F})$

(excluding sensor accuracy)

 $\pm 0.04^{\circ}\text{C}(\pm 0.07^{\circ}\text{F}) @ 155^{\circ}\text{C}(311^{\circ}\text{F})$ $\pm 0.05^{\circ}\text{C}(\pm 0.08^{\circ}\text{F}) @ 200^{\circ}\text{C}(392^{\circ}\text{F})$

Accuracy RTD

 $\pm 0.05^{\circ}\text{C}(\pm 0.09^{\circ}\text{F}) @ -50^{\circ}\text{C}(-58^{\circ}\text{F})$ * M53(68)426: -50°C to 200°C $\pm 0.05^{\circ}\text{C}(\pm 0.09^{\circ}\text{F}) @ 0^{\circ}\text{C}(32^{\circ}\text{F})$

(excluding sensor accuracy)

 $\pm 0.06^{\circ}\text{C}(\pm 0.10^{\circ}\text{F}) @ 155^{\circ}\text{C}(311^{\circ}\text{F})$ $\pm 0.06^{\circ}\text{C}(\pm 0.11^{\circ}\text{F}) @ 200^{\circ}\text{C}(392^{\circ}\text{F})$

Accuracy RTD

 $\pm 0.05^{\circ}\text{C}(\pm 0.09^{\circ}\text{F}) @ -50^{\circ}\text{C}(-58^{\circ}\text{F})$ * M50(90)426: -50°C to 200°C $\pm 0.05^{\circ}\text{C}(\pm 0.09^{\circ}\text{F}) @ 0^{\circ}\text{C}(32^{\circ}\text{F})$

(excluding sensor accuracy)

 $\pm 0.06^{\circ}\text{C}(\pm 0.11^{\circ}\text{F}) @ 155^{\circ}\text{C}(311^{\circ}\text{F})$ $\pm 0.06^{\circ}\text{C}(\pm 0.11^{\circ}\text{F}) @ 200^{\circ}\text{C}(392^{\circ}\text{F})$

Accuracy RTD

 $\pm 0.03^{\circ}\text{C}(\pm 0.05^{\circ}\text{F}) @ -60^{\circ}\text{C}(-76^{\circ}\text{F})$ * H100(90)617: -60°C to 180°C $\pm 0.03^{\circ}\text{C}(\pm 0.05^{\circ}\text{F}) @ 0^{\circ}\text{C}(32^{\circ}\text{F})$

(excluding sensor accuracy)

 $\pm 0.03^{\circ}\text{C}(\pm 0.05^{\circ}\text{F}) @ 100^{\circ}\text{C}(212^{\circ}\text{F})$ $\pm 0.03^{\circ}\text{C}(\pm 0.05^{\circ}\text{F}) @ 180^{\circ}\text{C}(392^{\circ}\text{F})$

Accuracy RTD

 $\pm 0.02^{\circ}\text{C}(\pm 0.04^{\circ}\text{F}) @ -80^{\circ}\text{C}(-112^{\circ}\text{F})$ H120(90)672: -80°C to 260°C $\pm 0.02^{\circ}\text{C}(\pm 0.04^{\circ}\text{F}) @ 0^{\circ}\text{C}(32^{\circ}\text{F})$

(excluding sensor accuracy)

 $\pm 0.02^{\circ}\text{C}(\pm 0.04^{\circ}\text{F}) @ 100^{\circ}\text{C}(212^{\circ}\text{F})$ $\pm 0.02^{\circ}\text{C}(\pm 0.04^{\circ}\text{F}) @ 260^{\circ}\text{C}(500^{\circ}\text{F})$

Accuracy RTD

 $\pm 0.03^{\circ}\text{C}(\pm 0.04^{\circ}\text{F}) @ -200^{\circ}\text{C}(-328^{\circ}\text{F})$ *Pt100 MILL: -200°C to 850°C $\pm 0.03^{\circ}\text{C}(\pm 0.05^{\circ}\text{F}) @ -90^{\circ}\text{C}(-130^{\circ}\text{F})$

(excluding sensor accuracy)

 $\pm 0.03^{\circ}\text{C}(\pm 0.06^{\circ}\text{F}) @ -50^{\circ}\text{C}(-58^{\circ}\text{F})$ $\pm 0.04^{\circ}\text{C}(\pm 0.06^{\circ}\text{F}) @ 0^{\circ}\text{C}(32^{\circ}\text{F})$ $\pm 0.05^{\circ}\text{C}(\pm 0.08^{\circ}\text{F}) @ 155^{\circ}\text{C}(311^{\circ}\text{F})$ $\pm 0.06^{\circ}\text{C}(\pm 0.10^{\circ}\text{F}) @ 320^{\circ}\text{C}(608^{\circ}\text{F})$ $\pm 0.06^{\circ}\text{C}(\pm 0.11^{\circ}\text{F}) @ 420^{\circ}\text{C}(788^{\circ}\text{F})$ $\pm 0.08^{\circ}\text{C}(\pm 0.14^{\circ}\text{F}) @ 660^{\circ}\text{C}(1220^{\circ}\text{F})$ $\pm 0.10^{\circ}\text{C}(\pm 0.17^{\circ}\text{F}) @ 850^{\circ}\text{C}(1562^{\circ}\text{F})$

INPUT SPECIFICATIONS**ACCURACY IN °C/°F**

Accuracy RTD

 $\pm 0.01^{\circ}\text{C}(\pm 0.01^{\circ}\text{F}) @ 15^{\circ}\text{C}(59^{\circ}\text{F})$

*YSI-400: 15°C to 50°C

 $\pm 0.01^{\circ}\text{C}(\pm 0.02^{\circ}\text{F}) @ 50^{\circ}\text{C}(122^{\circ}\text{F})$

(excluding sensor accuracy)

Accuracy Pt100 reference input

 $\pm 0.01^{\circ}\text{C}(\pm 0.02^{\circ}\text{F}) @ -200^{\circ}\text{C}(-328^{\circ}\text{F})$

(excluding sensor accuracy)

 $\pm 0.02^{\circ}\text{C}(\pm 0.03^{\circ}\text{F}) @ -90^{\circ}\text{C}(-130^{\circ}\text{F})$ $\pm 0.02^{\circ}\text{C}(\pm 0.03^{\circ}\text{F}) @ -50^{\circ}\text{C}(-58^{\circ}\text{F})$ $\pm 0.02^{\circ}\text{C}(\pm 0.03^{\circ}\text{F}) @ 0^{\circ}\text{C}(32^{\circ}\text{F})$ $\pm 0.03^{\circ}\text{C}(\pm 0.05^{\circ}\text{F}) @ 155^{\circ}\text{C}(311^{\circ}\text{F})$ $\pm 0.03^{\circ}\text{C}(\pm 0.05^{\circ}\text{F}) @ 320^{\circ}\text{C}(608^{\circ}\text{F})$ $\pm 0.04^{\circ}\text{C}(\pm 0.06^{\circ}\text{F}) @ 420^{\circ}\text{C}(788^{\circ}\text{F})$ $\pm 0.05^{\circ}\text{C}(\pm 0.08^{\circ}\text{F}) @ 660^{\circ}\text{C}(1220^{\circ}\text{F})$ $\pm 0.05^{\circ}\text{C}(\pm 0.09^{\circ}\text{F}) @ 850^{\circ}\text{C}(1562^{\circ}\text{F})$

* Available upon request on selected markets.

PTC-125 A/B/C

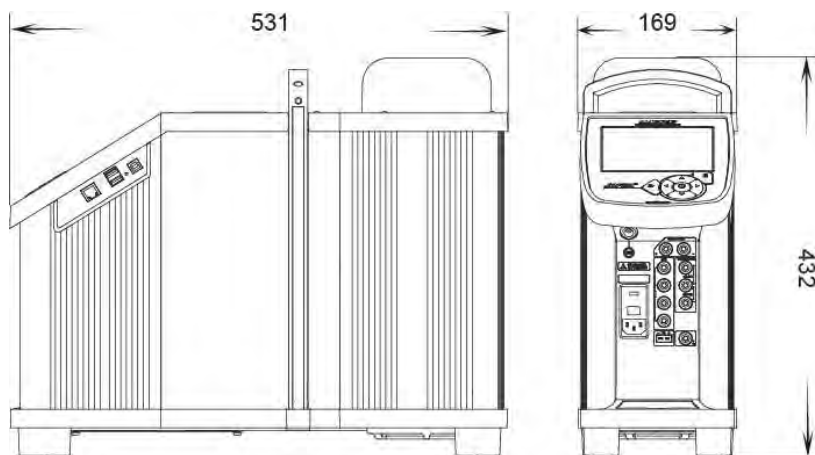

PTC-155/350/425/660 A/B/C

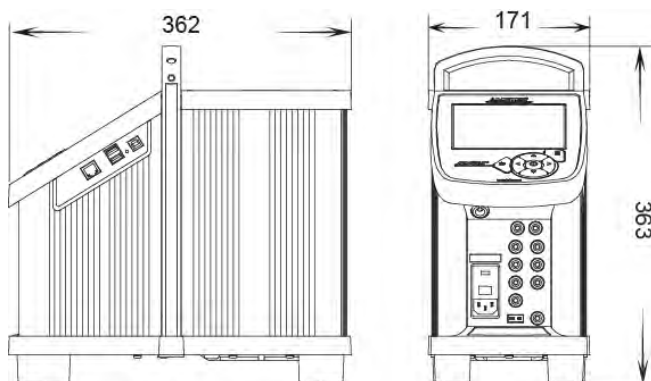

9.0 List of accessories

All parts listed in the list of accessories can be obtained from the factory through our dealers.

Please contact your dealer for assistance if you require parts, which do not appear on the list.

List of accessories

Accessories	Parts no.
Fuse 230V, 5AF (PTC-350/425/660 only)	127573
Fuse 250V, 8AT	127211
Fuse 250V, 4AT	127210
Fuse 115V, 10AF (PTC-350/425/660 only)	60B302
Tool for insertion tube	60F170
Set of silicone plugs (PTC-125/155 only)	126280
Heat shield (PTC-660 only)	127375
Carrying case	128095
Carrying case with trolley	127292
Carrying case (PTC-125)	128524
Mains cable, 115V, US, type B	60F135
Mains cable, 240V, UK, type C	60F136
Mains cable, 220V, South Africa, type D	60F137
Mains cable, 220V, Italy, type E	60F138
Mains cable, 240V, Australia, type F	60F139
Mains cable, 230V, Europe, type A	60F140
Mains cable, 230V, Denmark, type G	60F141
Mains cable, 220V, Switzerland, type H	60F142
Mains cable, 230V, Israel, type I	60F143
Thermocouple male plug type K	120517
Thermocouple male plug type N	120514
Thermocouple male plug type T	120515
Thermocouple male plug type Cu-Cu	120519
Thermocouple male plug type J	120516

List of accessories

Accessories	Parts no.
Thermocouple male plug type R/S	120518
USB cable	127278
Electronical ref. manual +JOFRACAL PC software	127429
Dust filter (PTC-125 only)	128222
Cleaning brush \varnothing 4mm	122832
Cleaning brush \varnothing 6mm	60F174
Cleaning brush \varnothing 8mm	122822
Support rod set for sensors	127277
Extra fixture for sensor grip	125066
Extra sensor grip	125067
Set of test cables	104203
Cable for STS-150-A-966, LEMO/LEMO 6-pol, 650 mm.	127131
Reference probe STS-150 90°, with accredited certificate, STS-150A912EH diameter 4mm, (-90°C to 125°C) (PTC-125)	
Reference probe STS-150 90°, with accredited certificate, STS-102A030EH diameter 4mm, (-45°C to 155°C) (PTC-155)	
Reference probe STS-150 90°, with accredited certificate, STS-150A915EH diameter 4mm, (-25°C to 155°C) (PTC-155)	
Reference probe STS-150 90°, with accredited certificate, STS-150A935EH diameter 4mm, (0°C to 350°C) (PTC-350)	
Reference probe STS-150 90°, with accredited certificate, STS-150A966EH diameter 4mm, (0°C to 425°C) (PTC-425)	
Reference probe STS-150 90°, with accredited certificate, STS-150A966EH diameter 4mm, (0°C to 660°C) (PTC-660)	

10.0 Standard insertion tubes



Caution...

Use of other insertion tubes may reduce performance of the calibrator. To get the best results out of your calibrator, the insertion tube dimensions, tolerance and material are critical. We highly advise using the JOFRA insertion tubes, as they guarantee trouble free operation.

PARTS NO. FOR STANDARD INSERTION TUBES WITH HOLE FOR 4 MM REF. SENSOR - UNDRILLED

Sensor size	PTC-125 A/B/C (Aluminium tubes)	PTC-155 A/B/C (Aluminium tubes)	PTC-350 A/B/C (Aluminium tubes)	PTC-425 A/B/C (Brass tubes)	PTC-660 A/B/C (Brass tubes)
Undrilled	128453	127935	127988	129720	128029
Undrilled with ref. hole	128455*	127936	127989	129721	128030

PARTS NO. FOR STANDARD INSERTION TUBES – MULTI-HOLE – METRIC

Insert type	PTC-125 A/B/C (Aluminium tubes)	PTC-155 A/B/C (Aluminium tubes)	PTC-350 A/B/C (Aluminium tubes)	PTC-425 A/B/C (Brass tubes)	PTC-660 A/B/C (Brass tubes)
Type M01	128456	127962	128015	129697	128056
Type M02	128457	127963	128016	129698	128057
Type M03	128458	127964	128017	129699	128058
Type M04	128459	127965	128018	129700	128059
Type M07	128462	127966	128019	129701	128060
Type M08	128463	127967	128020	129702	128061
Type M09	128464	-	-	-	-
Set of 4 pcs. Inserts, 3mm to 12mm (13mm) □	128466 □	127976	128022	129748	128067

**PARTS NO. FOR STANDARD INSERTION TUBES –
MULTI-HOLE – IMPERIAL**

Insert type	PTC-125 A/B/C (Aluminium tubes)	PTC-155 A/B/C (Aluminium tubes)	PTC-350 A/B/C (Aluminium tubes)	PTC-425 A/B/C (Brass tubes)	PTC-660 A/B/C (Brass tubes)
Type M05	128460	127970	128023	129703	128063
Type M06	128461	127972	128025	129704	128065
Type M10	128465	127973	128026	129705	128066
Type M11	-	127971	128024	129706	128064
Set of 3 pcs. Inserts, 1/8" to 1/2" (7/16") [□]	128467 [□]	127977	128027	129749	128068

**PARTS NO. FOR STANDARD INSERTION TUBES WITH
HOLE FOR 4 MM REF. SENSOR - METRIC**

Sensor size	PTC-125 A/B/C (Aluminium tubes)	PTC-155 A/B/C (Aluminium tubes)	PTC-350 A/B/C (Aluminium tubes)	PTC-425 A/B/C (Brass tubes)	PTC-660 A/B/C (Brass tubes)
3 mm	128477*	127937	127990	129722	128031
4 mm	128478*	127938	127991	129723	128032
5 mm	128479*	127939	127992	129724	128033
6 mm	128480*	127940	127930	129725	128034
7 mm	128481*	127941	127994	129726	128035
8 mm	128482*	127942	127995	129727	128036
9 mm	128483*	127943	127996	129728	128037
10 mm	128484*	127944	127997	129729	128038
11 mm	128485*	127945	127998	129730	128039
12 mm	128486*	127946	127999	129731	128040
13 mm	128487*	127947	128000	129732	128041
14 mm	128488*	127948	128001	129733	128042
15 mm	128489*	127949	128002	129734	128043
16 mm	128490*	-	-	-	-
Set of above Metric inserts	128492*	127951	128004	129743	128045

**PARTS NO. FOR STANDARD INSERTION TUBES WITH
HOLE FOR 4 MM REF. SENSOR - IMPERIAL**

Sensor size	PTC-125 A/B/C (Aluminium tubes)	PTC-155 A/B/C (Aluminium tubes)	PTC-350 A/B/C (Aluminium tubes)	PTC-425 A/B/C (Brass tubes)	PTC-660 A/B/C (Brass tubes)
1/8"	128468*	127952	128005	129735	128046
3/16"	128469*	127953	128006	129736	128047
1/4"	128470*	127954	128007	129737	128048
5/16"	128471*	127955	128008	129738	128049
3/8"	128472*	127956	128009	129739	128050
7/16"	128473*	127957	128010	129740	128051
1/2"	128474*	127958	128011	129741	128052
9/16"	128475*	127959	128012	129742	128053
5/8"	128476*	127960	128013	-	-
Set of above Imperial inserts	128491*	127961	128014	129744	128055

NOTE: All insertion tubes (metric and imperial) for PTC-125/155 are supplied with a matching insulation plug.

- * The PTC-125 insertion tubes are delivered with holes for 4mm and 1/ 4" reference sensors.

AMETEK Sensors, Test & Calibration

A business unit of AMETEK Measurement & Calibration Technologies Division offering the following industry leading brands for test and calibration instrumentation.

JOFRA Calibration Instruments

Temperature Calibrators

Portable dry-block calibrators, precision thermometers and liquid baths. Temperature sensors for industrial and marine use.

Pressure Calibrators

Convenient electronic systems ranging from -25 mbar to 1000 bar - fully temperature-compensated for problem-free and accurate field use.

Signal Instruments

Process signal measurement and simulation for easy control loop calibration and measurement tasks.

M&G Deadweight Testers & Pumps

Pneumatic floating-ball or hydraulic piston dead weight testers with accuracies to 0.015% of reading. Pressure generators delivering up to 1,000 bar.

Crystal Pressure

Digital pressure gauges and calibrators that are accurate, easy-to-use and reliable. Designed for use in the harshest environments; most products carry an IS, IP67 and DNV rating.

Lloyd Materials Testing

Materials testing machines and software that guarantees expert materials testing solutions. Also covering Texture Analysers to perform rapid, general food testing and detailed texture analysis on a diverse range of foods and cosmetics.

Davenport Polymer Test Equipment

Allows measurement and characterization of moisture-sensitive PET polymers and polymer density.

Chatillon Force Measurement

The hand held force gauges and motorized testers have earned their reputation for quality, reliability and accuracy and they represent the de facto standard for force measurement.

Newage Hardness Testing

Hardness testers, durometers, optical systems and software for data acquisition and analysis.



www.ametekcalibration.com

United Kingdom

Tel +44 (0)1243 833 302
caluk.sales@ametek.com

France

Tel +33 (0)1 30 68 89 40
general.lloyd-instruments@ametek.fr

Germany

Tel +49 (0)2159 9136 510
info.mct-de@ametek.de

Denmark

Tel +45 4816 8000
jofra@ametek.com

USA

Florida
Tel +1 (800) 527 9999
cal.info@ametek.com

California

Tel +1 (800) 444 1850
crystal@ametek.com

India

Tel +91 22 2836 4750
jofra@ametek.com

Singapore

Tel +65 6484 2388
jofra@ametek.com

China

Shanghai
Tel +86 21 5868 5111

Beijing

Tel +86 10 8526 2111
jofra.sales@ametek.com.cn